

TR62P

Cooker size	60x60 cm
N. of cavities with energy label	2
Cavity heat source	ELECTRICITY
Hob type	Gas
Type of main oven	Thermo-ventilated
Type of second oven	Static
Cleaning system main oven	Ever Clean enamel
EAN code	8017709210632
Energy efficiency class	A
Energy efficiency class, second cavity	A

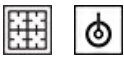

Aesthetics



Aesthetic	Victoria	Type of control knobs	Smeg Victoria
Design	Victoria	Controls colour	Stainless steel
Colour	Cream	No. of controls	6
Command panel finish	Enamelled metal	Serigraphy colour	Black
Logo	assembled 50's	Display name	Electronic 5 buttons
Logo position	Upstand	Door	With frame
Upstand	Yes	Glass type	Black
Hob colour	Black enamel	Handle	Smeg Victoria
Type of pan stands	Cast Iron	Handle Colour	Brushed stainless steel
Type of control setting hob	Control knobs	Plinth	Anthracite

Programs / Functions main oven

No. of cooking functions 4
 Traditional cooking functions



Static



Small grill



Large grill



Base

Hob technical features

UR			
Total no. of cook zones 4			
Front left - Gas - 2UR (dual) - 4.20 kW			
Rear left - Gas - Semi Rapid - 1.80 kW			
Rear right - Gas - Semi Rapid - 1.80 kW			
Front right - Gas - AUX - 1.00 kW			
Type of gas burners	Standard	Gas safety valves	Yes
Automatic electronic ignition	Yes	Burner caps	Matt black enamelled

Main Oven Technical Features



No. of lights	1	Full glass inner door	Yes
Net volume of the cavity	61 l	Removable inner door	Yes
Gross volume, 1st cavity	70 l	Total no. of door glasses	2
Cavity material	Ever Clean enamel	No. of thermo-reflective door glasses	1
No. of shelves	4	Safety Thermostat	Yes
Type of shelves	Metal racks	Cooling system	Tangential
Light type	Halogen	Usable cavity space dimensions (HxWxD)	316x460x412 mm
Light Power	40 W	Temperature control	Electro-mechanical
Cooking time setting	Start and Stop	Circular heating element - Power	2700 W
Removable door	Yes		

Options Main Oven

Timer	Yes	Minimum Temperature	50 °C
End of cooking acoustic alarm	Yes	Maximum temperature	245 °C

Second Oven Technical Features



Net volume of the second cavity	35 l	No. thermo-reflective door glasses	1
Gross volume, 2nd cavity	41 l	Safety Thermostat	Yes
Cavity material	Ever Clean enamel	Cooling system	Tangential
No. of shelves	2	Usable cavity space dimensions (HxWxD)	169x440x443 mm
Type of shelves	Metal racks	Temperature control	Electro-mechanical
No. of lights	1	Lower heating element - power	1200 W
Light type	Halogen	Upper heating element - Power	1000 W
Light Power	40 W	Grill element - power	1700 W
Removable door	Yes	Large grill - Power	2700 W
Full glass inner door	Yes	Grill type	Electric
Removable inner door	Yes		

No. total door glasses	2	Tilting grill	Yes
------------------------	---	---------------	-----

Options Auxiliary Oven

Minimum Temperature	50 °C	Maximum temperature	245 °C
---------------------	-------	---------------------	--------

Accessories included for Main Oven & Hob



Moka stand	1	Grill mesh	1
Rack with back and side stop	2	Telescopic Guide rails, partial Extraction	1
40mm deep tray	1		

Accessories included for Secondary Oven

Rack with back and side stop	1	Grill mesh	1
40mm deep tray	1		

Electrical Connection

Plug	Not present	Electric cable	Installed, Single phase
Electrical connection rating	5500 W	Power supply cable length	120 cm
Current	24 A	Additional connection modalities	Double and Three Phase
Voltage	220-240 V	Frequency	50/60 Hz
Voltage 2 (V)	380-415 V	Terminal block	5 poles

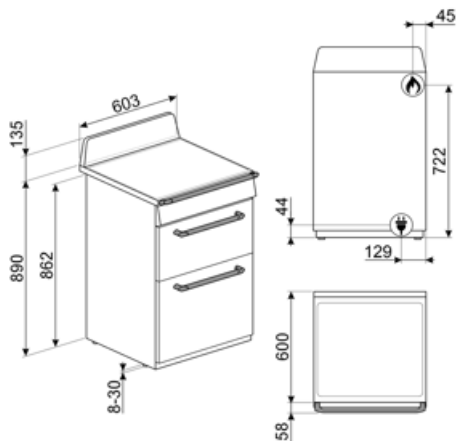

Not included accessories



KIT1TR6N

Splashback black, 60cm ,suitable for TR62 Victoria cookers



AIRFRY

Air fryer rack AIRFRY . Ideal for recreating traditional frying in the oven, but with fewer calories and less fat. It allows you to cook quickly and simply dishes such as French fries, fried vegetables and fish, ensuring perfect browning and crispiness.



SFLK1

Child lock



GTP

Partially extractable telescopic guides (1 level), suitable for traditional ovens. Made in stainless steel, they guarantee stability and facilitate the smooth extraction of the trays.



PRTX

Refractory pizza stone with handles. D=35cm Not suitable for microwave ovens. Suitable for gas ovens, to be put on the griddle.



BNP608T

Teflon-coated tray, 8mm depth, to be placed on the grid



BGTR9

Cast iron grill plate suitable for 90 cm Victoria, 60 and 90 cm Master and Sinfonia cookers



KITH60

Height extension kit (950 mm), black, suitable for TR60 cookers



BN620-1

Enamelled tray suitable for 45cm and 60cm ovens. Depth 20 mm. Perfect for a wide range of savoury and sweet baking.



BBQ

Double sided plate BBQ. Suitable for recreating succulent and crispy dishes in the oven with the typical taste of grilled cooking. The ribbed side is particularly suitable for meats and cheeses. The smooth side for fish, seafood and vegetables.



STONE

Rectangular refractory stone Ideal for cooking pizzas with the same results as a typical wood-fired oven. Can also be used for baking bread, focaccias and other recipes such as pies, flans or biscuits Dimensions:L42 x H1,8 x P37,5 cm.



PALPZ

Pizza shovel with folding handle. Dimensions L31.5 x H32.5 cm. Easy and convenient to use and store. Perfect for serving pizza, bread and savory pastries in a safe and professional way.



GTT

Totally extractable telescopic guides (1 level), suitable for traditional ovens. Made in stainless steel, they guarantee stability and facilitate the smooth extraction of the trays.

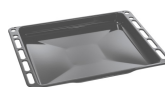

BN640



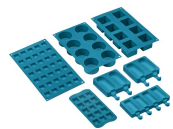

















Enamelled tray suitable for 45cm and 60cm ovens. Depth 540 mm. Perfect for cooking and roasting meat and fish in sauces. Also ideal for experimenting with lighter and crunchy side dishes



SMOLD

Set of 7 silicone moulds for ice creams, ice lollies, pralines, ice cubes or to portion food. Usable from -60°C to +230°C

Symbols glossary (TT)

 <p>Heavy duty cast iron pan stands: for maximum stability and strength.</p>	
 <p>Installation in column: Installation in column</p>	 <p>Air cooling system: to ensure a safe surface temperatures.</p>
 <p>Double glazed doors: Number of glazed doors.</p>	 <p>Ever Clean Enamel: Ever Clean enamel is applied electrostatically, corner to corner and edge to edge to prevent cracking or cracks over time. It is a particular pyrolytic enamel, resistant to acids which, in addition to being pleasantly bright, promotes greater cleaning of the oven walls, thanks to its lower porosity. It is baked at over 850 ° C and slowly polymerized at a scientifically determined rate to ensure uniform depth and strength Ever Clean enamel creates an impeccable finish both on the inside of the oven and on the trays, making the surfaces of the oven incredibly easy to maintain over time as it reduces the adhesion of fat during cooking</p>
 <p>Static: Traditional cooking suitable for the preparation of one dish at a time. The fan is not active and the heat comes from below and from above at the same time. Static cooking is slower and more delicate, ideal in order to get well cooked and dry dishes even inside. Ideal for cooking all types of roasts, fatty meats, bread, filled cakes.</p>	 <p>Base: the heat comes only from the bottom of the cavity. The fan is not active. Ideal for sweet and savory pies, cobblers and pizzas. Designed to complete cooking and make food more crunchy This symbol in gas ovens indicates the gas burner.</p>
 <p>Grill: Very intense heat coming only from above from a double heating element. The fan is not active. Provides excellent grilling and gratinating results. Used at the end of cooking, it gives a uniform browning to dishes.</p>	 <p>Half grill: For rapid cooking and browning of foods. Best results can be obtained by using the top shelf for small items, the lower shelves for larger ones, such as chops or sausages. For half grill heat is generated only at the centre of the element, so is ideal for smaller quantities.</p>
 <p>Gas ovens offer instantaneous heat control, reduced cooking times and the ability to bake at much lower temperatures than electric ovens.</p>	 <p>All glass inner door: All glass inner door, a single flat surface which is simple to keep clean.</p>
 <p>The inner door glass: can be removed with a few quick movements for cleaning.</p>	 <p>Side lights: Two opposing side lights increase visibility inside the oven.</p>
 <p>The oven cavity has 2 different cooking levels.</p>	 <p>The oven cavity has 4 different cooking levels.</p>
 <p>Telescopic rails: allow you to pull out the dish and check it without having to remove it from the oven entirely.</p>	 <p>Electronic control: Allows you to maintain temperature inside the oven with the precision 2-3 ° C. This enables to cook meals that are very sensitive to temperature changes, such as cakes, souffles, puddings.</p>
 <p>Tilting grill: the tilting grill can be easily unhooked to move the heating element and clean the roof of the appliance in one simple step.</p>	 <p>Ultra rapid burners: Powerful ultra rapid burners offer up to 5kw of power.</p>



The capacity indicates the amount of usable space in the oven cavity in litres.



The capacity indicates the amount of usable space in the oven cavity in litres.



Knobs control

Benefit (TT)

True-convection

The best cooking performances guaranteed by ventilated circular flow

Multiple fans and heating elements guarantee the perfect aerodynamic heat flow, allowing homogeneous and quicker cooking inside the cavity.

Gas hob

Gas provides permanent control of the heat source and the temperature change is immediate

Equipped with a thermocouple, the gas supply is cut off if the flame is extinguished for greater safety.

Ever Clean Enamel

Easy oven cleaning thanks to special pyrolytic enamel

Isothermic Cavity

The best cooking performance at the highest energy efficiency

Tangential cooling

New cooling system with tangential fan and airflow from the door to the splashback

Multilevel halogen light

Internal halogen lighting on different levels guarantees excellent visibility

Buttons control

Easy and intuitive timer setting with a simple buttons

Telescopic guides

Easy extraction and safe insertion of trays into the oven thanks to telescopic guides

Adjustable height

Cooker top flushed with the working area thanks to adjustable feet

Removable inner glass

Internal door glasses are easily removable for complete cleaning

Multilevel cooking

Several cooking levels allow maximum flexibility of use

Cold door

During any function, the external door glass is cold, avoiding any risk of burns

AirFry (AIRFRY optional accessory)

Lighter and tastier food thanks to airfry basket (optional accessory)

BBQ (optional accessory)

Barbeque cooking directly in the oven with the double-sided grill (BBQ optional accessory)

Pizza stone (optional accessory)

Baking with refractory stone for soft and crispy pizza and yeast products (STONE optional accessory)