

<b>PRECAUTIONS</b>	<b>36</b>	Digital programmer	44
General safety instructions	36	First use	44
For this appliance	39	Using the oven	45
Appliance purpose	40	Cooking advice	48
This user manual	40	Mini guide to accessories	49
Manufacturer's liability	40	Discover the recipes	49
Identification plate	40	Information for Supervisory Bodies	49
Disposal	40	Special functions	49
Information for European Control Bodies	40	Secondary functions	51
Energy efficiency technical data	41	Settings	52
To save energy	41	Other settings	54
Light sources	41	<b>CLEANING AND MAINTENANCE</b>	<b>54</b>
How to read the user manual	41	Cleaning the appliance	54
<b>DESCRIPTION</b>	<b>42</b>	Cleaning the door	55
General description	42	Cleaning the oven cavity	56
Control panel	42	Special cleaning functions	57
Other parts	42	Vapor Clean (on some models only)	57
Accessories	43	Pyrolytic (on some models only)	58
Optional accessories (can be purchased separately)	43	Extraordinary maintenance	59
<b>USE</b>	<b>43</b>	<b>INSTALLATION</b>	<b>60</b>
Preliminary operations	43	Electrical connection	60
Using the accessories	44	Positioning	61

We advise you to read this manual carefully, which contains all the instructions for maintaining the appliance's aesthetic and functional qualities. For further information on the product: [www.smeg.com](http://www.smeg.com)

## PRECAUTIONS

### General safety instructions

#### Risk of personal injury

- **ATTENTION:** during use, the appliance and its accessible parts become very hot. Children must be kept away from the appliance.
- **ATTENTION:** during use, the appliance and its accessible parts become very hot. Never touch the heating elements during use.
- Protect your hands by wearing oven gloves when moving food inside the oven.
- Never try to put out a fire or flames with water: turn off the appliance and smother the flames with a fire blanket or other appropriate cover.
- This appliance may be used by children aged at least 8 and by people of reduced physical, sensory or mental capacity, or lacking in experience in the use of electrical appliances, provided that they are supervised or instructed by adults who are responsible for their safety.

- Children must not play with the appliance.
- Keep children under the age of 8 at a safe distance unless they are constantly supervised.
- Keep children under the age of 8 away from the appliance when it is in use.
- Cleaning and maintenance must not be carried out by unsupervised children.
- The cooking process must always be monitored. A short cooking process must be continuously surveyed.
- Never leave the appliance unattended during cooking operations where fats or oils could be released, as these could then heat up and catch fire. Be very careful.
- Do not pour water directly onto very hot trays.
- Keep the oven door closed during cooking.
- If you need to move food or at the end of cooking, open the door 5 cm for a few seconds, let the steam come out, then open it fully.
- Do not insert pointed metal objects (cutlery or utensils) into the slots in the appliance.
- Switch off the appliance immediately after use.
- DO NOT USE OR STORE FLAMMABLE MATERIALS NEAR THE APPLIANCE.
- DO NOT USE AEROSOLS IN

THE VICINITY OF THIS APPLIANCE WHILST IT IS IN USE.

- DO NOT MODIFY THIS APPLIANCE.
- Installation and servicing should be carried out by qualified personnel in accordance with current standards.
- Do not try to repair the appliance yourself or without the assistance of a qualified technician.
- Do not pull the cable to unplug the appliance.

### **Risk of damaging the appliance**

- Do not use abrasive or corrosive detergents (e.g. scouring powders, stain removers and metallic sponges), rough or abrasive materials or sharp metal scrapers on glass parts as this could cause scratch the surface and break the glass. Use wooden or plastic utensils.
- Do not sit on the appliance.
- Do not use cleaning products containing chlorine, ammonia or bleach on parts made of steel or that have metallic surface finishes (e.g. anodizing, nickel- or chromium-plating).
- Racks and trays should be inserted as far as they will go into the side guides. The mechanical safety locks that prevent them from being

removed must face downwards and towards the back of the oven cavity.

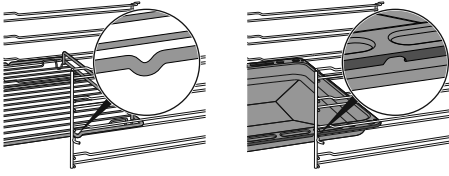

- Do not use steam jets to clean the appliance.
- Do not spray any spray product near the appliance.
- Do not obstruct ventilation openings and heat dispersal slots.
- Fire hazard: never leave objects in the oven cavity.
- DO NOT FOR ANY REASON USE THE APPLIANCE AS A SPACE HEATER.
- Do not use plastic cookware or containers when cooking food.
- Do not place sealed tins or containers in the oven cavity.
- Remove all trays and racks which are not required during cooking.
- Do not cover the bottom of the oven cavity with aluminium or tin foil sheets.
- Do not place pans or trays directly on the bottom of the oven cavity.
- If necessary, you can use the tray rack (supplied or sold separately, depending on the model) by placing it on the bottom as a support for cooking.

- If you wish to use greaseproof paper, place it so that it will not interfere with the hot air circulation inside the oven cavity.
- Do not use the open door to rest pans or trays on the internal glass pane.
- Never use the oven door to lever the appliance into place when fitting.
- Avoid exerting too much pressure on the door when open.
- Do not use the handle to lift or move this appliance.

### For pyrolytic appliances

- When the pyrolytic function is in use, the surfaces could reach temperatures that are higher than usual. Keep children at a safe distance.
- Before starting the pyrolytic cycle, remove any food residues or large spills from previous cooking operations from the inside of the oven.
- Before starting the pyrolytic cycle, remove all accessories from the oven cavity.
- Before starting the pyrolytic cycle, switch off the burners or electric hot plates of the hob installed above the oven.

### Installation and maintenance

- THIS APPLIANCE **MUST NOT BE INSTALLED** IN A BOAT OR

## CARAVAN.

- The appliance must not be installed on a pedestal.
- Position the appliance into the cabinet cut-out with the help of a second person.
- To prevent any possible overheating, the appliance should not be installed behind a decoration door or a panel.
- Installation and servicing should be carried out by qualified personnel in accordance with current standards.
- Have the electrical connection performed by authorised technical personnel.
- The appliance must be connected to earth in compliance with electrical system safety standards.
- Use cables withstanding a temperature of at least 90 °C.
- The tightening torque of the screws of the terminal supply wires must be 1.5 - 2 Nm.
- If the power cable becomes damaged, contact technical support immediately to arrange for it to be replaced in order to avoid possible hazards.
- **WARNING:** while positioning the appliance, make sure that the power supply cable is not caught or damaged.
- Always use any necessary/required personal protective equipment (PPE) before performing any work on the appliance (installation, maintenance, positioning or movement).
- Before performing any work on the appliance, switch off the power supply.
- Allow the appliance to be disconnected after installation, via an accessible plug or a switch in the case of a fixed connection.
- Fit the power line with an all-pole circuit breaker with a contact separation distance sufficient to provide complete disconnection in category III overvoltage conditions, pursuant to installation regulations.
- **WARNING:** Make sure that the appliance has been switched off and disconnected from the mains power supply or that the mains power has been switched off before replacing the interior lighting bulbs.
- The bulbs used in this appliance are specific for household appliances; do not use them for home lighting.
- This appliance can be used up to a maximum altitude of 4,000 metres above sea level.

### For this appliance

- Do not rest any weight or sit on the open door of the appliance.
- Take care that no objects are

stuck in the doors.

- Do not install/use the appliance outdoors.
- (on some models only) Only use the temperature probe provided or recommended by the manufacturer.

### Appliance purpose

This appliance is intended for cooking food in the home environment. Every other use is considered inappropriate. It cannot be used:

- in employee kitchens, shops, offices and other working environments.
- in farms/farmhouses.
- by guests in hotels, motels and residential environments.
- In bed and breakfast accommodation.

### This user manual

- This user manual is an integral part of the appliance and must therefore be kept in its entirety and within the user's reach for the whole working life of the appliance.
- Read this user manual carefully before using the appliance.
- The explanations in this manual include images, which describe all that regularly appears on the display. However, it should be kept in mind that the appliance may be equipped with an updated version of the system, and as such, all that appears on the display may differ from those in the manual.

### Manufacturer's liability

The manufacturer declines all liability for damage to persons or property caused by:

- use of the appliance other than that specified;
- failure to comply with the instructions in the user manual;
- tampering with any part of the appliance;

- use of non-original spare parts.

### Identification plate

The identification plate bears the technical data, serial number and brand name of the appliance. Do not remove the identification plate for any reason.

### Disposal



This appliance conforms to the WEEE European directive (2012/19/EU) and must be disposed of separately from other waste at the end of its service life.

The appliance does not contain substances in quantities sufficient to be considered hazardous to health and the environment, in accordance with current European directives.



#### Power voltage Danger of electrocution

- Disconnect the mains power supply.
- Unplug the appliance.

To dispose of the appliance:

- Cut the power cable and remove it.
- Deliver the appliance to the appropriate recycling centre for electrical and electronic equipment waste, or return it to the retailer when purchasing an equivalent product, on a one for one basis.

Our appliances are packaged in non-polluting and recyclable materials.

- Deliver the packing materials to the appropriate recycling centre.



#### Plastic packaging Danger of suffocation

- Do not leave the packaging or any part of it unattended.
- Do not let children play with the plastic bags.

### Information for European Control Bodies

#### Fan forced mode

the ECO function used to define the energy efficiency class complies with the specifications of European standard EN 60350-1.

#### Conventional heating mode

To perform the energy consumption test in the fan-heated function, it is necessary to use the

FAN-HEATED cooking function and skip the preheating phase (see section "Preheating phase" in the USE chapter).

## Energy efficiency technical data

Information in accordance with the European energy labelling and ecodesign regulations is contained in a separate document accompanying the product instructions.

These data are present in the "Product information sheet" that can be downloaded from the website at the page dedicated to the product in question.

## To save energy

- Only preheat the appliance if the recipe requires you to do so. The preheating stage can be disabled for all functions (see chapter "Preheating") apart from the PIZZA (preheating cannot be disabled) and ECO functions (no preheating stage).
- When using the functions (including the ECO function), avoid opening the door during cooking.
- Unless otherwise indicated on the package, defrost frozen foods before placing them in the oven.
- When cooking several types of food it is recommended to cook the foods one after the other to make the best use of the already hot oven.
- Use dark metal moulds: They help to absorb the heat better.
- Remove all trays and racks which are not required during cooking.
- Stop cooking a few minutes before the time normally used. Cooking will continue for the remaining minutes with the heat which has accumulated inside the oven.
- Reduce any opening of the door to a minimum to avoid heat dispersal.
- Keep the inside of the oven clean at all times.

## Light sources

- This appliance contains user-replaceable light sources.

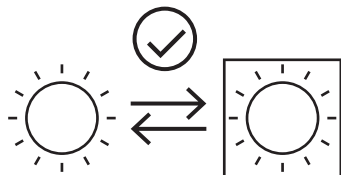

- The light sources contained in the appliance are declared suitable for operation at ambient temperature  $\geq 300^{\circ}\text{C}$  and intended for use in high temperature applications such as ovens.
- This appliance contains light sources of efficiency class "G".

## How to read the user manual

This user manual uses the following reading conventions:



Warning/ Caution



Information/ Advice

# DESCRIPTION

## General description

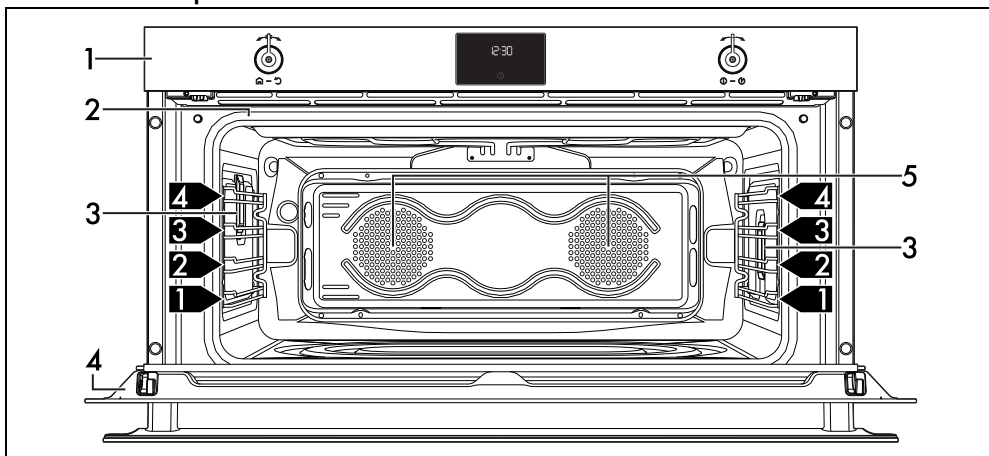

1 Control panel

2 Seal

3 Light bulb

4 Door

5 Fan

**1,2,3...** Frame shelf

## Control panel

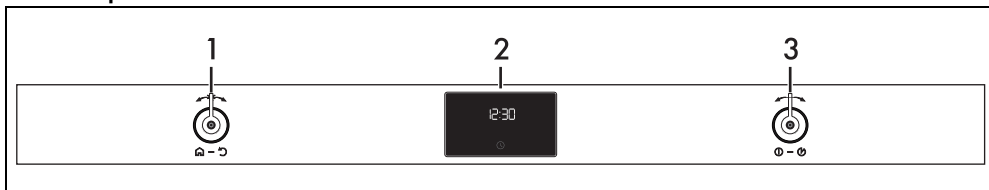

### 1 Function knob

By means of these touch keys or this knob you can:

- turn the appliance on and off;
- select a function.



Turn the Function knob to the position 0 to immediately complete any cooking operation.

### 2 Digital programmer

Displays the current time, the selected cooking temperature, power and function and any time set.

### 3 Temperature knob

Using these touch keys or this knob, you can set:

- the cooking temperature;
- the duration of a function;
- programmed cooking cycles;
- the current time;

- temporarily start or stop a function.

## Other parts

### Shelves

The appliance features shelves to position trays and racks at different heights. The insertion heights are indicated from the bottom upwards.

### Cooling fan

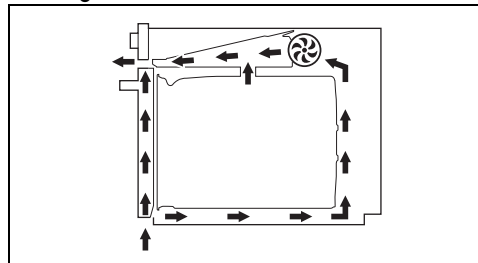





The fan cools the appliance and comes into operation during cooking.

The fan causes a steady outflow of air from above the door which may continue for a short period of time even after the appliance has been turned off.

### Oven lighting

The appliance's interior lighting comes on:

- When the door is opened.
- when the  button is pressed on the display;
- when any function, apart from the  -  -  functions are selected (depending on the model).

### Accessories

- Not all accessories are available on some models.
- The accessories intended to come into contact with food are made of materials that comply with the provisions of current legislation.
- Original supplied and optional accessories can be requested to Authorised Assistance Centres. Use only original accessories supplied by the manufacturer.

#### Rack

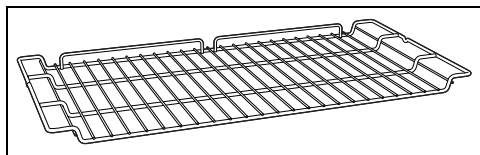

Used for supporting containers with food during cooking.

#### Tray

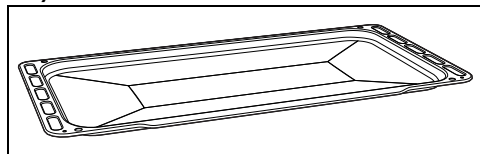

Useful for cooking cakes, pizzas, oven-baked desserts and biscuits.

#### Deep tray

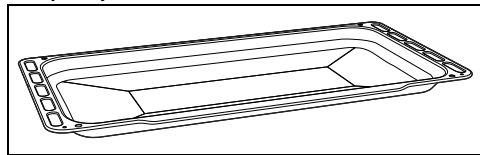

Useful for collecting fat from foods placed on the rack above and for cooking pies, pizzas, baked desserts, biscuits, etc.

#### Tray rack

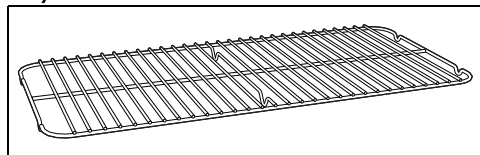

To be placed over the top of the tray; for cooking foods which may drip.

### Optional accessories (can be purchased separately)

#### PPR9 (refractory stone)

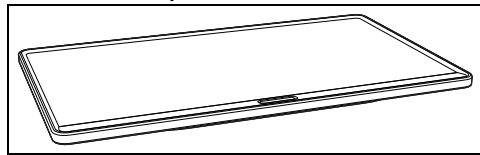

Ideal accessory for baking bread (pizza, bread, focaccia...), but you can also use it for more delicate preparations such as biscuits.

## USE

### Preliminary operations



See General safety instructions.

- Remove any protective film from the outside or inside of the appliance, including accessories.
- Remove any labels (apart from the technical

data plate) from the accessories and shelves.

- Remove and wash all the appliance accessories (see chapter "CLEANING AND MAINTENANCE").

#### First heating

1. Set a cooking time of at least one hour (see paragraph "Using the oven").



- Heat the empty oven compartment at the maximum temperature to burn off any residues left by the manufacturing process.

When heating the appliance

- air the room;
- don't stay.

## Using the accessories

### Racks and trays

Racks and trays have to be inserted into the side guides until they come to a complete stop.

- The mechanical safety locks that prevent the rack from being removed accidentally must face downwards and towards the back of the oven cavity.

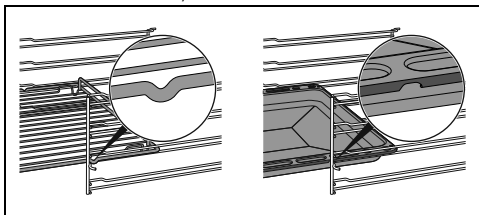

Gently insert racks and trays into the oven until they come to a stop.



Clean the trays before using them for the first time to remove any residues left by the manufacturing process.

### Tray rack

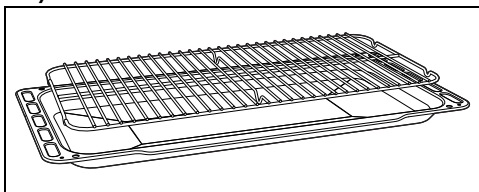

The tray rack has to be inserted into the tray. In this way fat can be collected separately from the food which is being cooked.

## Digital programmer

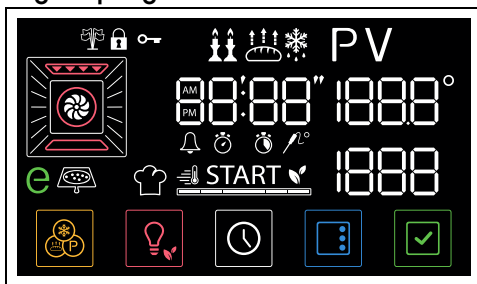

The parameters and values for the currently selected function will be indicated on the display. To use it, simply turn the functions and temperature knobs and/or press the buttons on the lower part of the display, depending on the operations to be performed by the appliance.

### First use



If the time is not set, the oven will not switch on.

When using the appliance for the first time or after a prolonged power failure, **00:00** will appear on the display and the  button will flash. In order to start a cooking function, the current time has to be set.

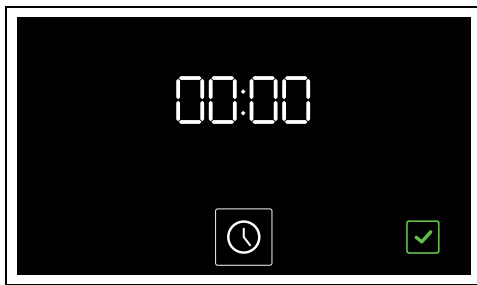



### Setting the time

- Press the  button.
- Turn the temperature knob to select the time format to display (**12h** or **24h**).





When you select the **12h** version, **AM** (am) or **PM** (pm) appear on the display.

- Press the  button to confirm and modify the time.

- Turn the temperature knob to adjust the hours.
- Press the  button to set the hours and move to the minutes.
- Turn the temperature knob to adjust the minutes.
- Press the  button to confirm.

 It may be necessary to change the current time, for example for daylight saving time.

 When the current time is shown, the display will be dimmed 2 minutes after the knobs were last used.

 To cancel the operation, press and hold the  button for a few seconds.

### Modifying the time

- In the main menu, hold down the  button for a few seconds.





- Modify the time as described in point 2 in the previous chapter.

### Using the oven

 See General safety instructions.

### Traditional cooking

 Cooking functions can be interrupted at any time by turning the function knob to the 0 position.

- Turn the function knob to the right or to the left to select the wished function (for example "FAN-ASSISTED ").

The  button and the text **START** start

flashing.

- Turn the temperature knob to the right or to the left to select the wished temperature (for example "200°C").

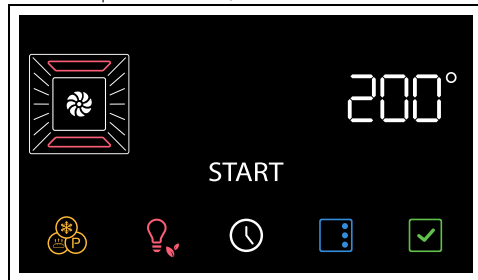

- Press the  button to start the function.



 When the door is opened, the function in progress is interrupted. The function resumes automatically when the door is closed.

### Preheating stage



Cooking itself is preceded by a preheating stage, which allows the appliance to heat to the cooking temperature more quickly.

This stage is indicated by the switching on of the indicator light  and by a progressive increase in the temperature level reached



 You can skip the preheating phase by holding down the  button for a few seconds.

At the end of preheating:

- the  indicator light switches off;
- the appliance beeps;
- the words **START** and the  button flash to indicate that the food can be introduced into the oven cavity.

### Cooking phase

- Open the door
- Place the dish with the food to be cooked into the oven cavity.
- Close the door.
  - or
  - If the dish with the food is already inside the oven cavity, press the  button to start cooking.

4. Check the cooking status of the food by turning on the internal light.

### End of cooking

5. To end cooking, turn the function knob to position 0 to exit the function.

### Timed cooking

 Timed cooking is the function that allows a cooking operation to be started and then ended after a specific length of time set by the user.

 When the door is opened, the function in progress is stopped. The function restarts automatically when the door is closed.

1. After selecting a cooking function and temperature, press the  button.

The indicator lights  and  flash on the display.

2. Turn the temperature knob to set the cooking duration, if required (from 1 minute to 13 hours) (for example "25 minutes").

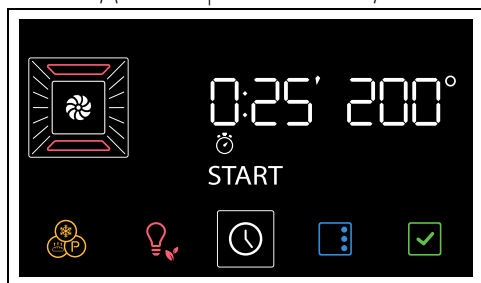

3. Press the  button to confirm the cooking duration.

 Bear in mind that a few minutes for oven preheating must be added to the cooking time.

4. Press the  button to start the function.

At the end of the preheating stage:

5. Place the food in the oven.
6. Close the door, cooking starts again automatically.



Timed cooking is indicated by the progressive decrease in the time shown on the numeric display and the progressive decrease of the progress bar .

When cooking ends, a sound is emitted and

**End** appears on the display.

7. Turn the function knob back to 0.

### How to cancel timed cooking

1. Press the  button briefly.
2. Turn the temperature knob anticlockwise to reset the cooking duration.
3. Press the  button to confirm.

### Programmed cooking

 Programmed cooking is the function that allows timed cooking to be stopped automatically at a time set by the user, after which the appliance will switch off automatically.

 For safety reasons, it is not possible to set the end of cooking time by itself without setting the cooking duration.

 If the proposed end of cooking time is kept and the programmed cooking does not start, add at least one minute to the cooking time

1. After selecting a cooking function and temperature, press the  button.

The indicator lights  and  flash on the display.

2. Turn the temperature knob to set the cooking duration, if required (from 1 minute to 13 hours) (for example "25 minutes").

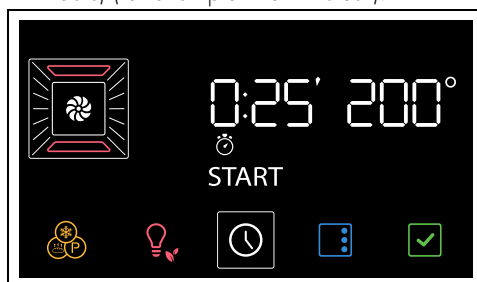

3. Press the  button.

The indicator lights  and  flash on the display.

- Turn the temperature knob to set the cooking end time (for example "13:15").

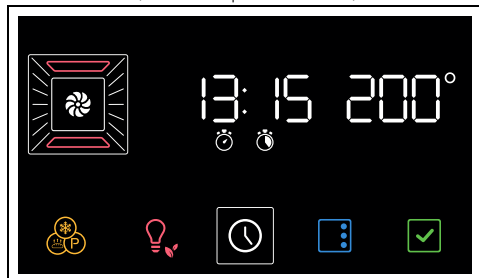

- Press the symbol  to confirm the cooking end time.
- Once you have confirmed the time, the function starts automatically.

The appliance waits for the set start time.

 The minutes required for pre-heating are already included in the end-of-cooking time.

When cooking ends, a sound is emitted and **End** appears on the display.

- Turn the function knob back to 0.

### How to cancel programmed cooking

- Press the  button briefly.

The indicator lights  and  flash on the display.

- Press the  button briefly.

The indicator lights  and  flash on the display.

- Turn the temperature knob anti-clockwise until the minimum settable cooking end time is reached

- Press the  button to confirm.

 This only cancels the programmed cooking. Timed cooking starts immediately together with the preheating stage.

 To interrupt cooking, turn the function knob to 0.

### Minute minder timer during cooking

 The minute minder timer does not stop the cooking operation but rather informs the user when the set time has run out.

- Press the  button.

The indicator lights  and  flash on the display.

- Press the  button.

The digits  and the indicator light  flash on the display.

- Turn the temperature knob to set the duration of the minute minder timer (from 1 minute to 23 hours).

- Press the  button to confirm.

When the minute minder finishes, a sound is emitted and the indicator light  on the display flashes.

- Touch the  button to exit from the function.

### List of traditional cooking functions

 Not all functions are available on some models.

#### STATIC

 Traditional cooking suitable for the preparation of one dish at a time. Ideal for cooking roasts, fatty meats, bread, pies.

#### FAN ASSISTED

 Intense and uniform cooking. Ideal for biscuits, cakes and multilevel cooking.

#### CIRCUAIRE

 The heat is distributed quickly and uniformly. Suitable for all dishes, ideal for cooking on multiple levels without mixing smells or flavours.

#### TURBO

 Allows quick cooking on multiple shelves without mixing the aromas. Perfect for large volumes that call for intense cooking.

## GRILL



It allows to obtain excellent grilling and grating results. Used at the end of cooking, it gives a uniform browning to the dishes.

## FAN-ASSISTED GRILL



Allows optimal grilling of even the thickest meats. Perfect for large cuts of meat.

## BOTTOM HEAT



The heat comes from the bottom of the cavity. Perfect for cakes, pies, tarts and pizzas.

## CIRCULAIRE + BOTTOM



Allows you to quickly finish cooking food that is already cooked on the surface but not internally. Ideal for quiches, suitable for all kinds of dishes.

## PIZZA



Function designed for cooking pizza. Perfect not just for pizzas, but also for biscuits and cakes.

## ECO



This function is particularly suitable for cooking on a single shelf with low energy consumption. It is recommended for all types of food, excluding those that can create a lot of humidity (such as vegetables). To obtain maximum energy savings and reduce cooking times, it is recommended to place food in the oven without preheating.



When using the ECO function, avoid opening the door during cooking.



Cooking (and preheating) times are longer with the ECO function and may depend on the amount of food in the oven.



The ECO function is a delicate cooking function and is recommended for food withstanding temperatures lower than 210°C; in case of cooking at higher temperatures, select another function.

## Cooking advice

### General advice

- Use a fan assisted function to achieve consistent cooking at several levels.
- It is not possible to shorten cooking times by increasing the temperature (the food could be overcooked on the outside and undercooked on the inside).

### Advice for cooking meat

- Cooking times vary according to the thickness and quality of the food and to consumer taste.
- Use a meat thermometer when roasting meat, or simply press on the roast with a spoon. If it is hard, it is ready; If not, it needs another few minutes cooking.

### Advice for cooking with the Grill and the Fan with grill

- Meat can be grilled even when it is put into the cold oven or into the preheated oven if you wish to change the effect of the cooking.
- When using the fan-assisted with grill function, we recommend that you preheat the oven before grilling.
- We recommend placing the food at the centre of the rack.
- With the Grill function, we recommend that you set the temperature to the maximum value to optimise cooking.

### Advice for cooking desserts/pastries and biscuits

- Use dark metal moulds: They help to absorb the heat better.
- The temperature and the cooking time depend on the quality and consistency of the dough.
- To check whether the dessert is cooked right through: At the end of the cooking time, put a toothpick into the highest point of the dessert. If the dough does not stick to the toothpick, the dessert is cooked.
- If the dessert collapses when it comes out of the oven, on the next occasion reduce the set temperature by about 10°C, selecting a longer cooking time if necessary.

### Advice for defrosting and proving

- Place frozen foods without their packaging in a lidless container on the first shelf of the oven.
- Avoid overlapping the food.

- To defrost meat, use the rack placed on the second level and a tray on the first level. In this way, the liquid from the defrosting food drains away from the food.
- The most delicate parts can be covered with aluminium foil.
- For successful proving, a container of water should be placed in the bottom of the oven.

### To save energy

- Stop cooking a few minutes before the time normally used. Cooking will continue for the remaining minutes with the heat which has accumulated inside the oven.
- Reduce any opening of the door to a minimum to avoid heat dispersal.
- Keep the inside of the appliance clean at all times.

### Slow cooking

Low-temperature preparations have slow cooking times (minimum 3 hours). If a pan with water is placed in the oven to collect cooking fat, there will be significant steam generation and thus condensation.

To avoid the risk of overflowing from the drip catcher at the bottom of the oven front, it is recommended to dry it with a sponge every 2-3 hours.

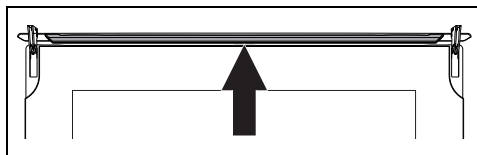

## Mini guide to accessories



Rack

We recommend the use of the grill as a support surface for baking moulds/casseroles.

The grill can be used as a base for grilling with the deep baking tray placed on a shelf below to collect the juices.



Tray

Use the baking tray for pastry preparations, for low thickness baking and for cooking without the addition of liquids.

We recommend using the STATIC function  on the desired shelf.



Deep tray

We recommend the use of the deep baking tray for cooking on one level only.

Place the deep baking tray on the centre shelf when using the fan-assisted functions. Place the

deep tray on the 2nd or 3rd shelf from below when using the STATIC  function.

Place the baking tray on the last shelf with the baking tray grill to cook in GRILL mode .



Tray rack

We recommend using the baking tray grill as a base to collect the juices from the grills.

## Discover the recipes

To consult the recipes developed for various categories of food and to get more information on cooking suggestions, we recommend visiting the dedicated page on the [www.smeg.com](http://www.smeg.com) website, which can be reached using the QR code on the leaflet supplied with the product.

## Information for Supervisory Bodies

### Fan forced mode

The ECO function used to establish the energy efficiency class is compliant with the specifications of European standard EN

60350-1.

See the “To save energy ” section in the INSTRUCTIONS chapter.

### Conventional heating mode

To use the STATIC mode, you have to skip the preheating stage (see the section “Preheating stage” in the USE chapter.

See the “To save energy ” section in the INSTRUCTIONS chapter.

### Special functions

- From position 0, turn the function knob to the

left by one position. The  button flashes.



To scroll through the available functions, press the  button until the desired special function is selected.





To exit the selected function (not yet started), hold down the button .

## DEFROSTING



This function allows you to defrost food on the basis of a selectable time.

- After entering the special functions menu, press the  button until the  function is selected.



If the indoor temperature is higher than expected, the function is not activated and every time the  button is pressed the appliance makes a beep. Let the appliance cool down before activating the function.

- Open the door.
- Place the food to be defrosted inside the oven.
- Close the door.
- Press the  button to confirm.
- Turn the temperature knob to set the defrosting time (from 1 minute to 13 hours) (e.g. "1:30").

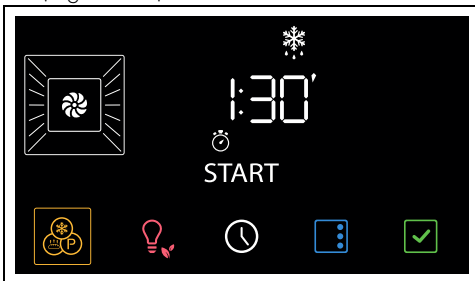

- Press the  button to start the function. At the end, **End** is displayed and flashes and a beep is activated.
- Turn the function knob to position 0 to exit the function.

- Below is a reference table with defrosting times by type of food.

Type	Weight (kg)	Time
Meats	0.5	1h 45m
Fish	0.4	0h 40m
Bread	0.3	0h 20m
Desserts	1.0	0h 45m

## PROVING



This function is particularly suitable for proving dough.

- After entering the special functions menu, press the  button until the  function is selected.



If the indoor temperature is higher than expected, the function is not activated and every time the  button is pressed the appliance makes a beep. Let the appliance cool down before activating the function.

- Open the door.
- Position the dough to prove on the second level.
- Close the door.
- Press the  button to confirm.

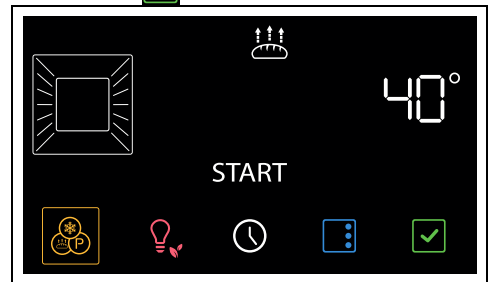

Turn the temperature knob to change the temperature value (from 25°C to 40°C)

- Press the  button to start the function.
- Turn the function knob to position 0 to exit the function.



For successful proving, a container of water should be placed in the bottom of the oven.

## SABBATH





This function results in the appliance operating in a particular way:

- Cooking can proceed indefinitely, it is not possible to set any cooking duration.
- No pre-heating will be performed.
- The cooking temperature which can be selected varies between 60-150°C.
- Oven light disabled, any operation such as opening the door (where present) or manual activation with the knob will not activate the light.
- The internal fan remains turned off.
- Knob illumination and audible prompts remain disabled.



After activating the Sabbath mode the settings cannot be altered. Any action on the knobs and/or on the display button will produce no effect; only the function knob remains active to allow you to return to the main menu.

1. After entering the special functions menu, press the  button until the  function is selected.
2. Press the  button to confirm.
3. Turn the temperature knob to set required temperature (for example "90°C").

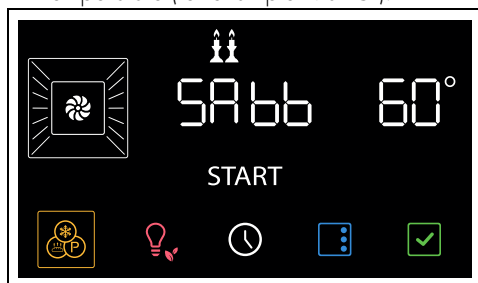

4. Press the  button to start the function.
5. Turn the function knob to position 0 to exit the function.

## Secondary functions

The buttons at the bottom of the display have some secondary functions:

## MINUTE MINDER TIMER





The minute minder timer only warns the user that the set number of minutes has passed.

1. Press the  button on the main menu.

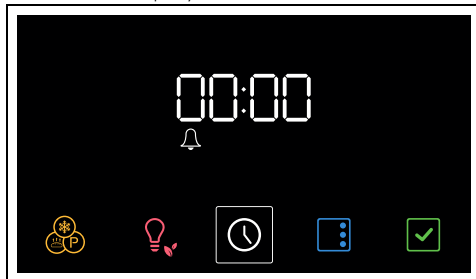
The digits  and the indicator light  flash on the display.



2. Turn the temperature knob to set the duration of the minute minder timer (from 1 minute to 23 hours).
3. Press the  button to confirm.
4. When the minute minder finishes, a sound is emitted and the indicator light  on the display flashes.
5. Touch the  button to exit from the function.

## TIME

1. Press and hold the  button on the main menu for a few seconds.

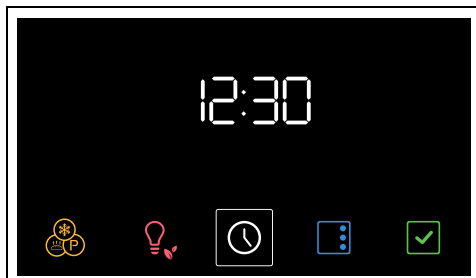





2. Turn the temperature knob to select the time format to display ( or ).



When you select the  version, **AM** (am) or **PM** (pm) appear on the display.





3. Press the  button to confirm and modify the time.
4. Turn the temperature knob to adjust the hours.
5. Press the  button to set the hours and move to the minutes.
6. Turn the temperature knob to adjust the minutes.
7. Press the  button to confirm.

 To cancel the operation, press and hold the  button for a few seconds.

## Settings

- Press the  button on the main menu.

 To quit the settings menu, hold down the  button for a few seconds.

## Controls lock (child safety)



 This mode allows the appliance to lock the controls automatically after 2 minutes of normal operation, without any intervention from the user.

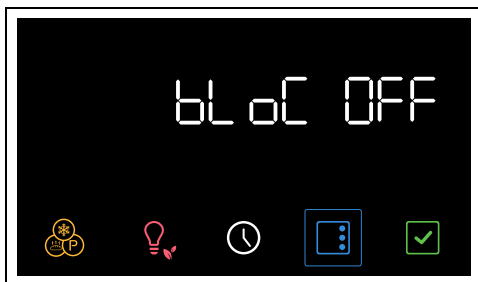

1. After having accessed the settings menu, press the  button to select the controls lock function.

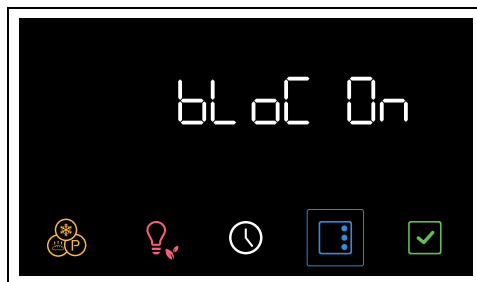

2. Turn the temperature knob to activate the controls lock function.



3. Press the  button to move to the next setting or press the  button to confirm.

 During normal operation, the controls lock is indicated by the  light coming on.

 If the buttons on the display are touched or the position of the knobs are changed, "Lock On" will appear on the display for two seconds".

To temporarily disable the lock:

1. during cooking, turn the temperature knob or press a button on the display.



2. When "Lock on" appears on the screen, press the  button for a few seconds.

The lock will become active again two minutes after the last setting.

## Showroom (for showrooms only)



 This mode allows the appliance to deactivate all heating elements, while keeping the control panel active.

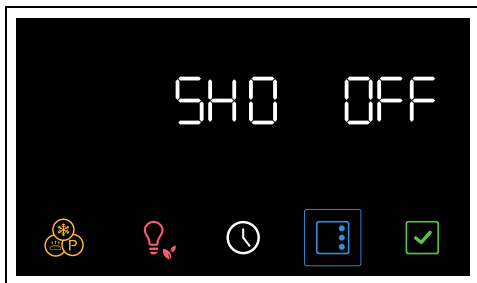

1. After entering the setting menu, press the  button until the show room function is selected.

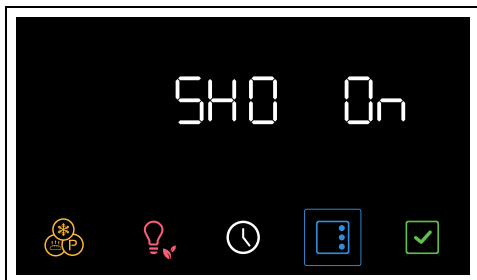

2. Turn the temperature knob to activate the showroom function.





3. Press the  button to go to the next setting or press the  button to confirm.

 The activated showroom is indicated on the display by the  indicator light on.

 To use the appliance normally, set this function to OFF.

### Keep warm

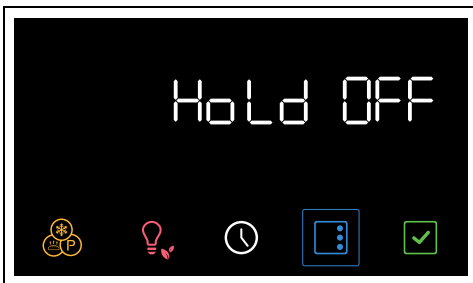

 This mode allows the appliance after cooking finishes with a cooking cycle for which a duration has been set (if this is not manually interrupted), to keep cooked food warm (at low temperatures) without altering the taste and aromas obtained during cooking.

1. After entering the setting menu, press the  button until the keep warm function is selected.

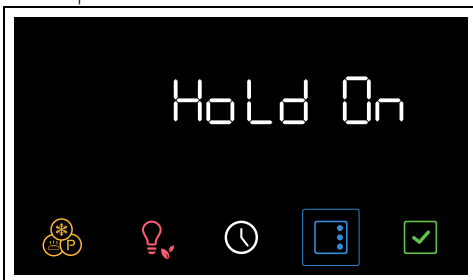

2. Turn the temperature knob to activate the keep warm function.



3. Press the  button to go to the next setting or press the  button to confirm.



 To use the appliance normally, set this function to OFF.

### Display brightness

 This mode allows the display brightness level to be selected.

1. After entering the setting menu, press the  button until the display brightness function is selected.



2. Turn the temperature knob to the right or left to select the desired brightness, from value 1 (low brightness) to value 5 (high brightness).
3. Press the  button to go to the next setting or press the  button to confirm.

 The display brightness function is factory set to high.

## Sound

 Whenever one of the display symbols is pressed, the appliance beeps. This setting disables these sounds.

1. After entering the setting menu, press the  button until the sound function is selected.

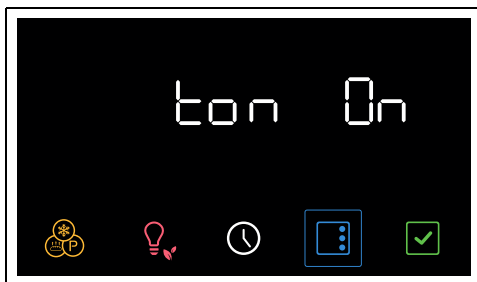

2. Turn the temperature knob to disable the sound associated with the touching of the symbols on the display.

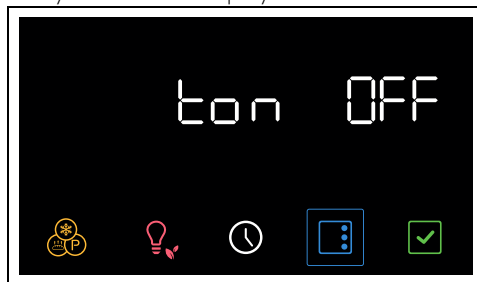



3. Press the  button to go to the next setting or press the  button to confirm.



## Other settings

### Eco light

 For greater energy savings, the lights inside the oven cavity are automatically deactivated approximately one minute after the start of cooking or after the door is opened.

 To stop the appliance from automatically deactivating the light after approximately one minute, set this mode to Off.

 The Eco light function is factory set to On.

- To deactivate the Eco light function, press the  key for a few moments.
- To reactivate the Eco light function, press the  key for a few moments.

# CLEANING AND MAINTENANCE

## Cleaning the appliance

 See General safety instructions.

### Cleaning the surfaces

To keep the surfaces in good condition, they should be cleaned regularly after use. Let them cool first.

### Ordinary daily cleaning

Always and only use specific products that do

not contain abrasives or chlorine-based acids. Pour the product onto a damp cloth and wipe the surface, rinse thoroughly and dry with a soft cloth or a microfibre cloth.

### Food stains or residues

Do not use steel sponges and sharp scrapers as they will damage the surface.

Use normal, non-abrasive products and a wooden or plastic tool, if necessary. Rinse thoroughly and dry with a soft cloth or a

microfibre cloth.

Do not allow residues of sugary foods (such as jam) to set inside the oven. If left to set for too long, they might damage the enamel lining of the oven.

## Cleaning the door

### Door disassembly

For easier cleaning it is recommended to remove the door and place it on a tea towel.

To remove the door proceed as follows:

1. Open the door completely and insert two pins into the holes on the hinges indicated in the figure.

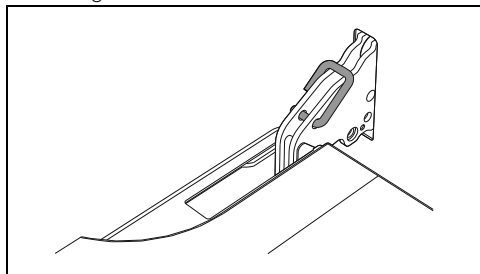

2. Grasp the door on both sides with both hands, lift it forming an angle of around 30° and remove it.

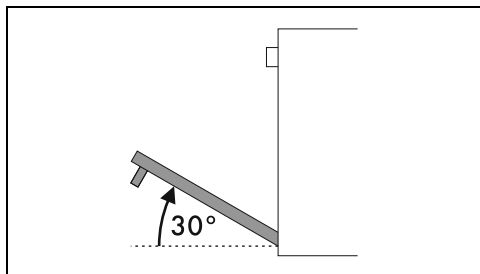

3. To reassemble the door, put the hinges in the relevant slots in the oven, making sure that grooved sections **A** are resting completely in the slots.

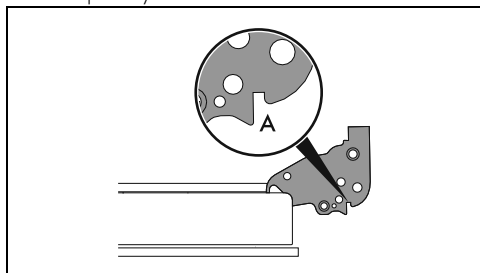

4. Lower the door and once it is in place remove the pins from the holes in the hinges.

## Cleaning the door glazing

The glass in the door should always be kept thoroughly clean. Use absorbent kitchen roll. In case of stubborn dirt, wash with a damp sponge and an ordinary detergent.

### Removing the internal glass panes

For easier cleaning the internal glass panes of the door can be removed.

1. Lock the door with the appropriate pins.
2. Remove the internal glass pane by pulling the rear part gently upwards, following the movement indicated by the arrows 1.

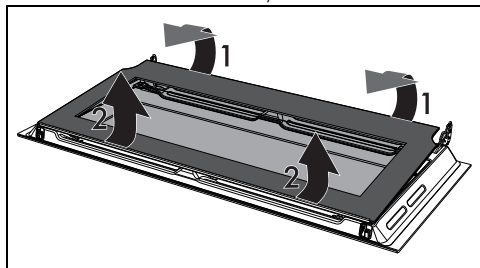

3. Pull the intermediate glass unit downwards from the door and then lift it upwards following the movement indicated by the arrows 2.

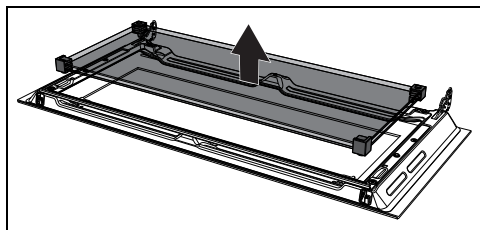

Note: In some models, the intermediate glass unit consists of two panes.

During this step, the upper grommets may come out of their seats.

- Insert the front grommets into their seats. The feet of the grommets must be facing the outer glass

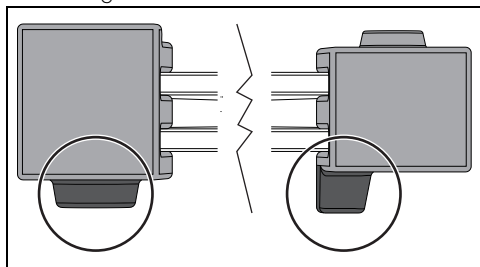

- Clean the external glass pane and the panes removed previously.

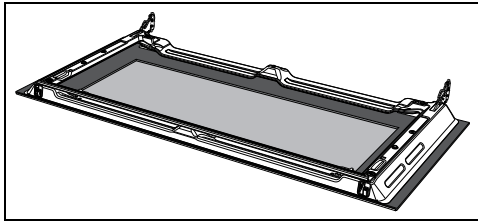

- Use absorbent kitchen roll. In case of stubborn dirt, wash with a damp sponge and neutral detergent.
- Reinsert the intermediate glass unit and reposition the inner glass.

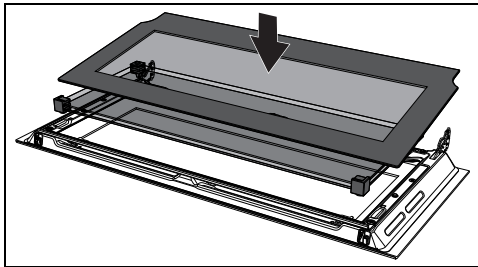

The intermediate glass pane must be repositioned on the open door so that the screen printing in the corner can be read from left to right (the rough part of the screen printing must face the external glass pane of the door).

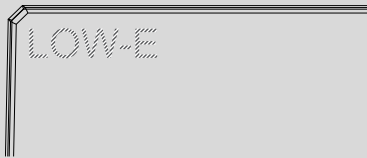

- Be sure to fit the 4 pins of the inner glass well into their seats on the door.

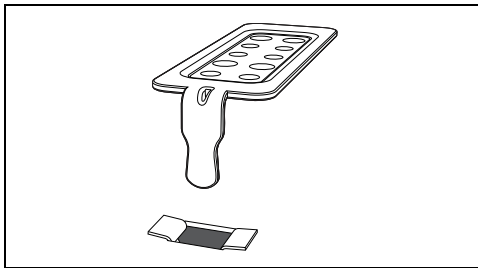

### Cleaning the oven cavity

In order to keep your oven in the best possible condition, clean it regularly after letting it cool

down.

Avoid letting food residue dry inside the oven cavity, as this could damage the enamel. Take out all removable parts before cleaning. For easier cleaning, it is recommended to remove:

- the door;
- The rack/tray support frames.



In the event you are using specific cleaning products, we recommend running the oven at maximum temperature for 15-20 minutes in order to eliminate any residue.

### Drying

Cooking food generates moisture inside the appliance. This is a normal phenomenon and does not affect the appliance's operation in any way.

Each time you finish cooking:

- Let the appliance cool down.
- Remove any dirt from inside the appliance.
- Dry the interior of the appliance with a soft cloth.
- Leave the door open until the inside of the appliance has dried completely.

### Removing rack/tray support frames

Removing the rack/tray support frames enables the sides to be cleaned more easily.

To remove the rack/tray support frames:

- Pull the frame towards the inside of the oven cavity to unhook it from its groove A, then slide it out of the seats B at the back.

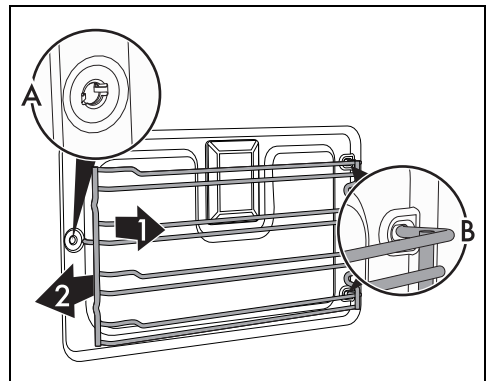

- When cleaning is complete, repeat the above procedures to put the rack/tray support frames back in.

## Special cleaning functions

- From position 0, turn the function knob to the left by one position. The  button flashes.

## Vapor Clean (on some models only)



See General safety instructions.



The Vapor Clean function is an assisted cleaning procedure that facilitates the removal of dirt. Thanks to this process, it is possible to clean the inside of the oven very easily. The dirt residues are softened by the heat and water vapour for easier removal afterwards.

### Preliminary operations

Before starting the Vapor Clean cycle:

- Completely remove all accessories from inside the oven.
- Remove the temperature probe, if present.
- Remove the self-cleaning panels, if present.
- Pour approx. 120 cc of water onto the floor of the oven. Make sure it does not overflow out of the cavity.
- Spray a water and washing up liquid solution inside the oven using a spray nozzle. Direct the spray towards the side walls, upwards, downwards and towards the deflector.



We recommend spraying approx. 20 times at the most.





Do not spray the deflector if it has a self-cleaning coating.

- Close the door.
- During the assisted cleaning cycle, wash the self-cleaning panels (where fitted), which were previously removed, separately in warm water and a small amount of detergent.

### Vapor Clean cycle setting



If the indoor temperature is higher than expected, the function is not activated and every time the  button is pressed the appliance makes a beep. Let the appliance cool down before activating the function.

- After entering the special functions menu, press the  button until the  function is selected.

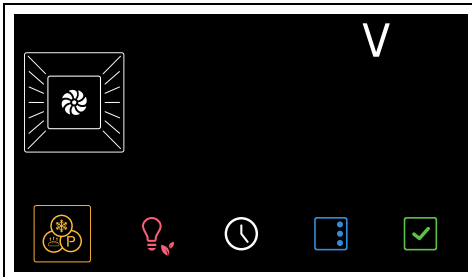

- Press the  button to confirm.

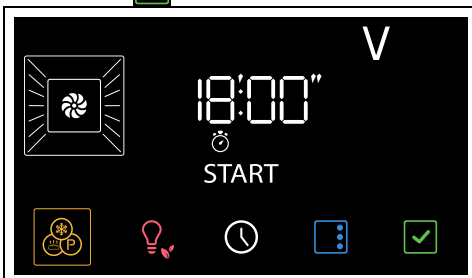

- Press the  button to start the function.



The duration and temperature parameters cannot be changed by the user.



At the end,  is displayed and flashes and a beep is activated.

- Turn the function knob to position 0 to exit the function.

### Programmed Vapor Clean cycle

It is possible to program the Vapor Clean function start time, like any cooking function.

- After selecting the Vapor Clean function, press the  button.

The  and  indicator lights on the display flashes.

- Turn the temperature knob to set the function end time.
- Press the  button to confirm.

The appliance waits until the set start time to start the Vapor Clean function.

## Vapor Clean End

1. Turn the function knob to 0 to exit from the function.
2. Open the door and wipe away the less stubborn dirt with a microfibre cloth.
3. Use a non-scratch sponge with brass filaments on hard to remove deposits.
4. In case of grease residues use specific oven cleaning products.
5. Remove the residual water inside the oven.
6. Replace the self-cleaning panels and the rack/tray support frames, if fitted.

For greater hygiene and to avoid foods taking on unpleasant odours:

- We recommend drying the inside of the oven with a fan assisted function at 160°C for around 10 minutes.
- If self-cleaning panels are fitted, we recommend that you dry the inside of the oven with a simultaneous catalytic cycle.



We recommend wearing rubber gloves for these operations.



We recommend removing the door in order to make the manual cleaning of the parts that are difficult to reach easier.

## Pyrolytic (on some models only)



See General safety instructions.



Pyrolytic cleaning is an automatic high-temperature cleaning procedure which causes dirt to dissolve. This process makes it possible to clean the inside of the oven very easily.

## Preliminary operations

Before starting the pyrolytic cycle:

- Clean the internal glass pane following the usual cleaning instructions.
- Remove any food residues or large spills from previous cooking operations from the inside of the oven.
- Completely remove all accessories from inside the oven.
- For very stubborn encrustations spray an oven cleaning product onto the glass (read the warnings on the product); leave for 60 minutes, then rinse and dry the glass using kitchen roll or a microfibre cloth.

- If present, remove the temperature probe.
- Remove the rack/tray support frames.
- Close the door.

## Pyrolytic function setting

1. After entering the special functions menu,

press the  button until the  function is selected.

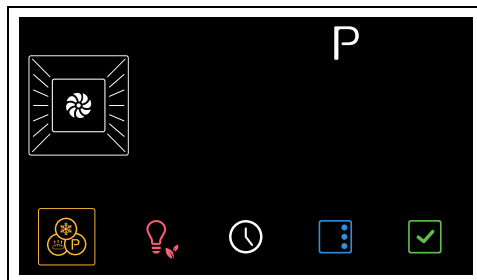

2. Press the  button to confirm.

The display shows the Pyrolytic function duration (factory set to 2:30 hours).

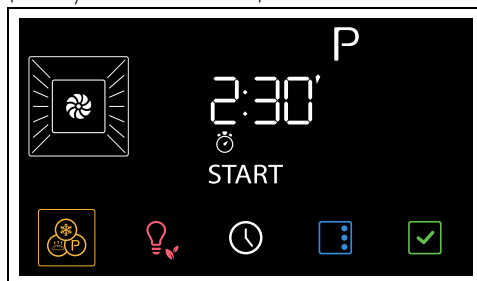

3. Turn the temperature knob to set the duration of the Pyrolytic cycle from a minimum of 2:00 hours to maximum of 3:00 hours.



Recommended pyrolytic cycle duration:

- Light dirt: 2:00
- Medium dirt: 2:30
- Heavy dirt: 3:00

4. Press the  button to confirm.



It is not possible to start the pyrolytic cycle if the temperature probe (if available) is plugged in.

5. Two minutes after the Pyrolytic cycle starts, the  indicator light comes on to indicate

that the door is locked by a device that prevents the door from being opened.



It is not possible to select any function once the door lock device has been activated.

At the end, **End** is displayed and flashes and a beep is activated.

6. Turn the function knob to position 0 to exit the function.



The door is locked until the temperature inside the oven cavity returns to a safe level.



During the Pyrolytic cycle the fans produce a more intense level of noise due to a greater rotation speed. This is an absolutely normal operation, intended to provide more effective heat dispersal. At the end of the pyrolytic cycle, the fans will continue to operate for long enough to avoid overheating the walls of adjacent units and the front of the oven.



During the first Pyrolytic cycle, unpleasant odours may occur due to the normal evaporation of oily manufacturing substances. This is an absolutely normal phenomenon which disappears after the first pyrolytic cycle.





If the pyrolytic cycle gives unsatisfactory results at minimum duration, it is recommended to set a longer time for subsequent cleaning cycles.

### Programmed pyrolytic function

It is possible to program the Pyrolytic cycle start time like all other cooking functions.

1. After selecting the Pyrolytic function, press  button.

The  and  indicator lights on the display flashes.

2. Turn the temperature knob to set the function end time.

3. Press the  button to confirm.

The appliance waits until the set start time to start

the Pyrolytic function.



It is not possible to select any function once the door lock device has been activated. It is always possible to switch the appliance off, by turning the function knob to the 0 position.

EN

### End of pyrolytic function

1. Turn the function knob to position 0 to exit the function.
2. Open the door and collect the residue deposited inside the oven cavity with a damp microfibre cloth.



We recommend wearing rubber gloves for these operations.



For easier manual cleaning of parts that are difficult to reach, we recommend removing the door.

### Extraordinary maintenance

#### Seal maintenance tips

The seal should be soft and elastic.

- To keep the seal clean, use a non-abrasive sponge and wash with lukewarm water.

#### Replacing the internal light bulb



Power voltage

Danger of electrocution

- Unplug the appliance.
  - Wear protective gloves.
1. Completely remove all accessories from inside the oven.
  2. Remove the rack/tray support frames.
  3. Use a tool (e.g. a spoon) to remove the bulb cover.

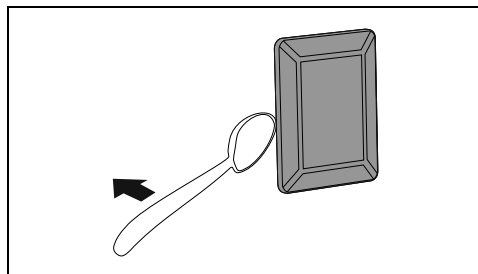





Take care not to scratch the enamel of the oven cavity wall.

4. Slide out and remove the light bulb.

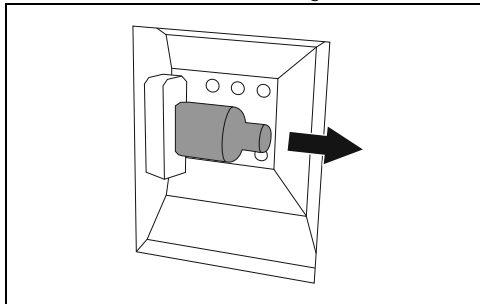

Do not touch the halogen light bulb directly with your fingers, use an insulating material.

5. Replace the light bulb with one of the same type (40 W).
6. Refit the cover. Ensure the moulded part of the glass (A) is facing the door.

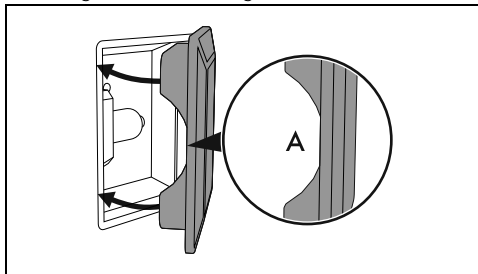

7. Press the cover completely down so that it attaches perfectly to the bulb support.

## INSTALLATION

### Electrical connection



See General safety instructions.

### General information

Check the mains characteristics against the data indicated on the plate.

The identification plate bearing the technical data, serial number and brand name is visibly positioned on the appliance.

Do not remove this plate for any reason.

The appliance must be connected to ground using a wire that is at least 20 mm longer than the other wires.

The appliance can work in the following modes:

- 220-240 V~

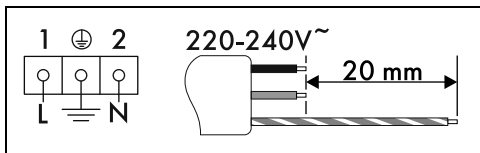

3 x 2.5 mm<sup>2</sup> three-core cable.



The values indicated above refer to the cross section of the internal lead.



The aforementioned power cables are sized taking into account the coincidence factor (in compliance with standard EN 60335-2-6).

### Fixed connection

Fit the power line with an all-pole circuit breaker with a contact separation distance sufficient to provide complete disconnection in category III overvoltage conditions, pursuant to installation regulations.

### For the Australian/New Zealand market:

The circuit breaker incorporated in the fixed connection must comply with AS/NZS 3000.

### Connection with plug and socket

Make sure that the plug and socket are of the same type.

Avoid using adapters, gang sockets or shunts as these could cause overheating and a risk of burns.

## Cable replacement



Power voltage  
Danger of electrocution

- Disconnect the mains power supply.

1. Unscrew the screws on the rear casing.

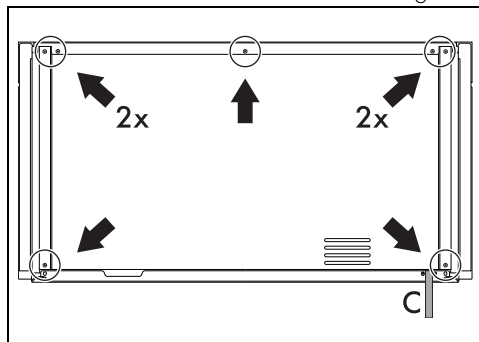

2. Lift the rear casing slightly and remove it to gain access to the terminal board.
3. Replace the cable.
4. Make sure that the cables (for the oven or any hob) follow the best route in order to avoid any contact with the appliance.

C = Position of the power cable.

## Positioning



See General safety instructions.

### Removing the rear hook

Before fitting the appliance, the cable hook on the rear cover must be removed using a pair of scissors or a special tool.

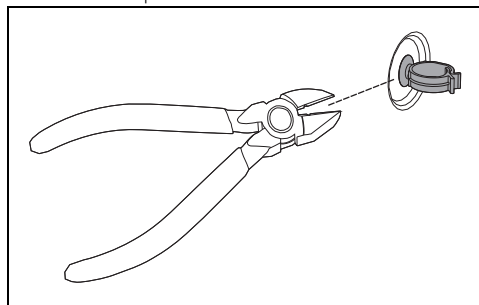

### Front panel seal

Glue the supplied seal to the rear part of the front panel to avoid water or other liquids from

leaking in.

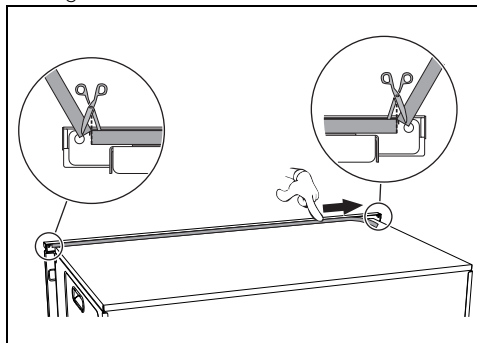

### Fastening bushings

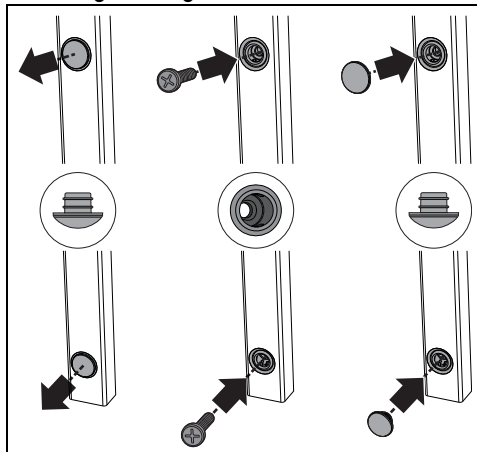

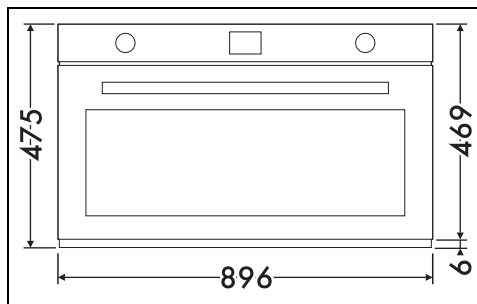

1. Remove the bushing covers on the front of the appliance.
2. Mount the appliance into the recess.
3. Secure the appliance to the cabinet using screws.
4. Cover the bushings with the previously removed covers.

### Appliance overall dimensions (mm)

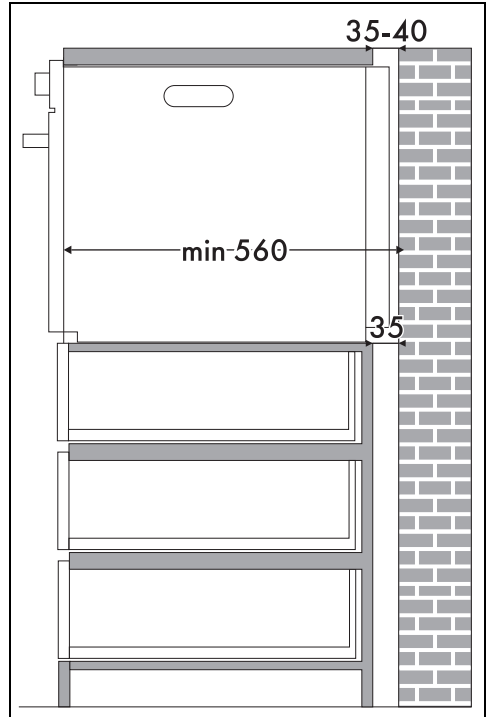
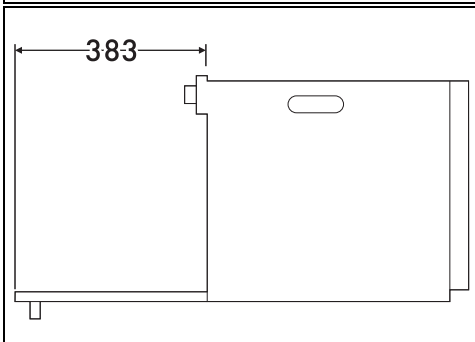
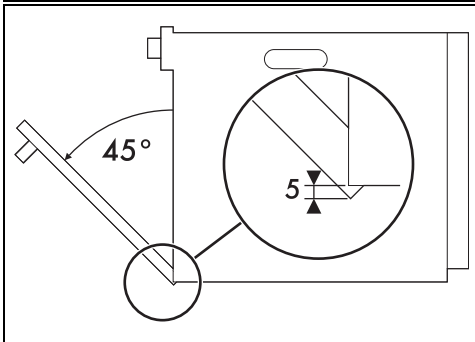
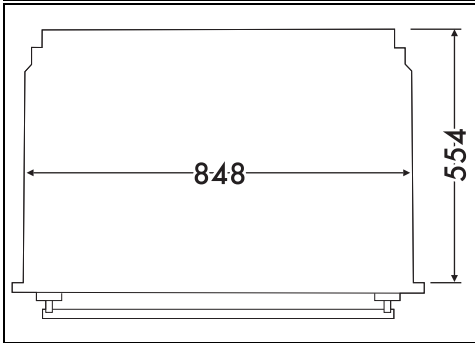
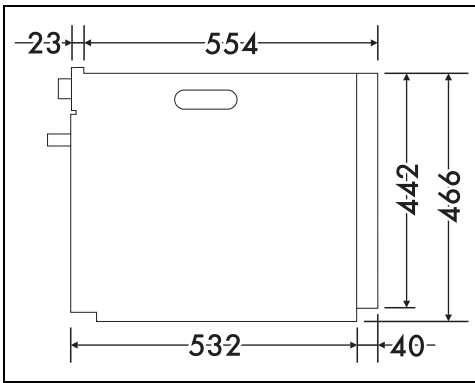

### Mounting into a column (mm)



 \* Make sure that the cabinet top/rear section has an opening approx. 35-40 mm deep.

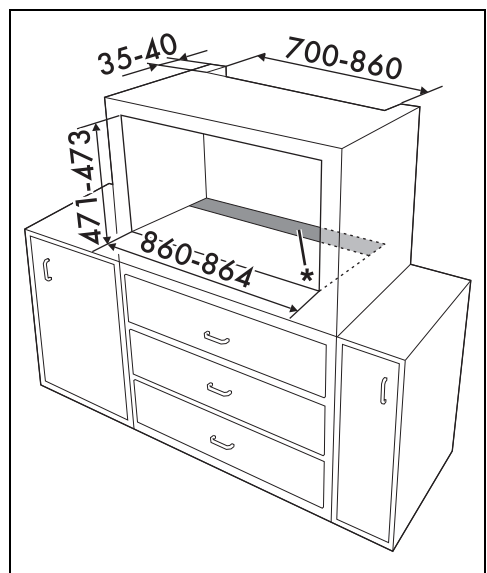

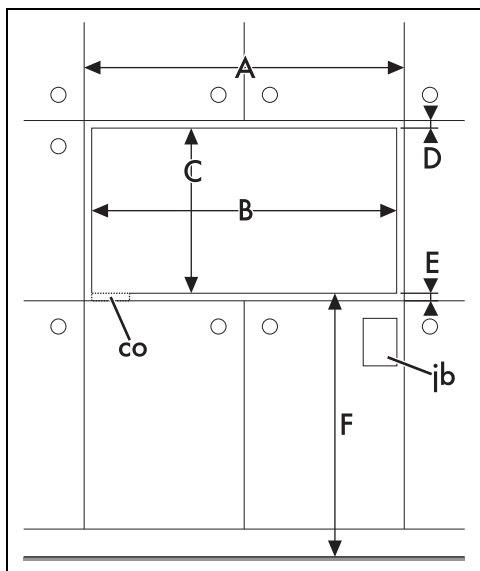

A min. 900 mm

B 860 - 864 cm

C 477 - 479 cm

D 9 - 11 cm

E min. 5 mm

F 121 - 1105 cm

G min. 560 mm

co Cutout for power cord (min. 6 cm<sup>2</sup>)

jb Electrical connection box

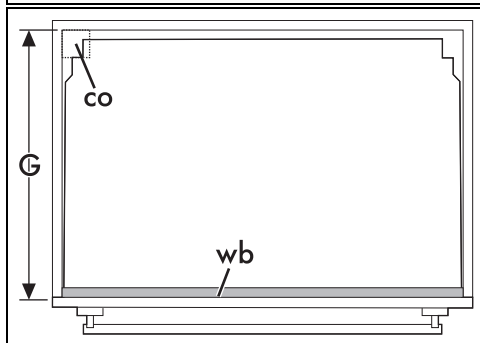
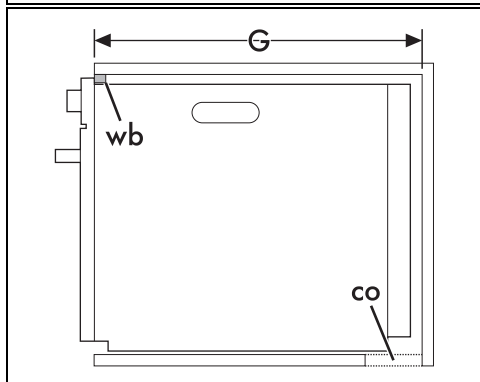

## Mounting under worktops (mm)

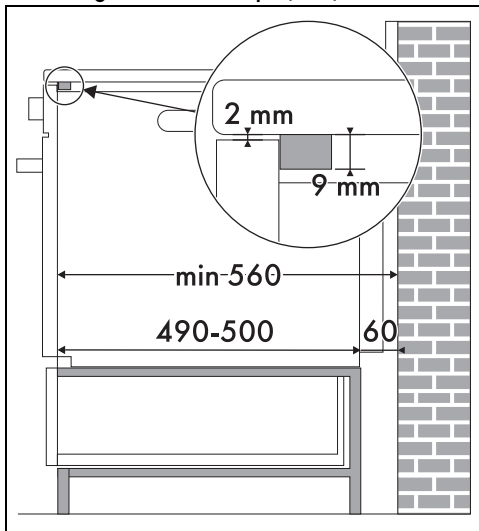

If the appliance is to be built-in under worktop, a wooden bar has to be installed order to use the seal that is glued to the back of the front panel to prevent water or other liquids leaking in.

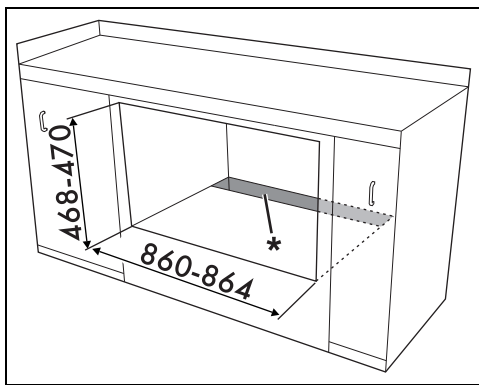

\* Make sure that the piece of furniture top/rear part has an opening approx. 60 mm deep.

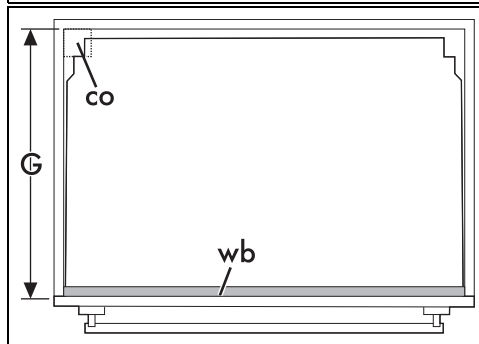
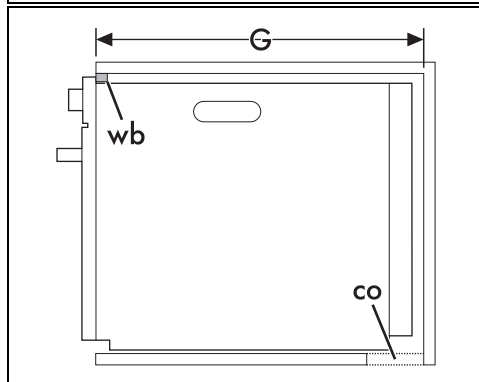
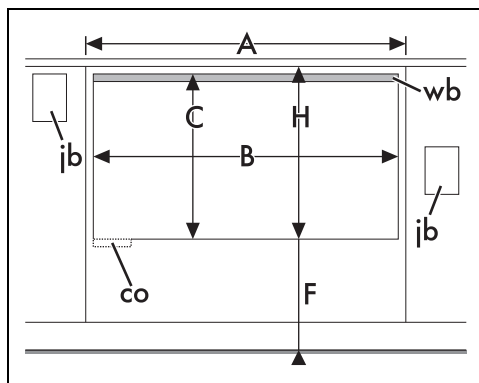

A min. 900 mm

B 860 - 864 cm

C 477 - 479 cm

F 121 - 1105 cm

G min. 560 mm

H min. 477 mm

co Cutout for power cord (min. 6 cm<sup>2</sup>)

jb Electrical connection box

wb Wooden bar (recommended)

## Mounting under worktops (mm) (pyrolytic models only)

Whenever a hob is installed above the oven, a wooden separator has to be installed at a minimum distance of 20 mm from the top of the oven to prevent overheating when the two appliances are used at the same time. It must only be possible to remove the separator by using suitable tools.

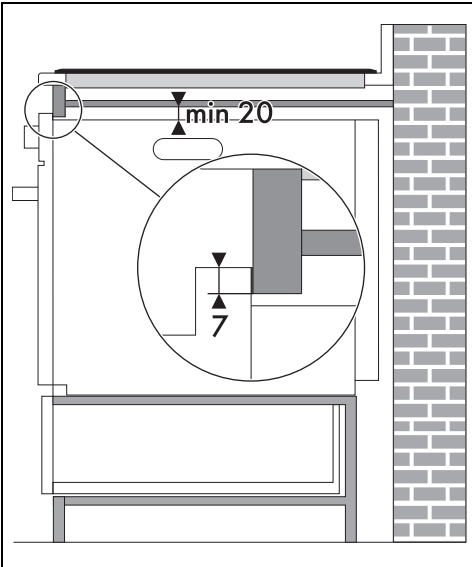
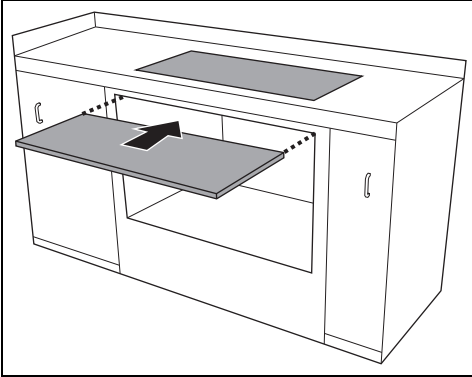

When using a wooden separator, a wooden bar has to be installed under the worktop in order to use the seal that is glued to the back of the front panel to prevent water or other liquids leaking in.