

Contents

1	Instructions	38
1.1	General safety instructions	38
1.2	Appliance purpose	41
1.3	Manufacturer's liability	42
1.4	This user manual	42
1.5	Identification plate	42
1.6	Disposal	42
1.7	How to read the user manual	43
2	Description	44
2.1	General Description	44
2.2	Control panel	45
2.3	Other parts	45
2.4	Available accessories	46
3	Use	47
3.1	Instructions	47
3.2	First use	47
3.3	Using the accessories	48
3.4	Using the oven	48
3.5	Cooking advice	54
4	Cleaning and maintenance	58
4.1	Instructions	58
4.2	Cleaning the appliance	58
4.3	Removing the door	58
4.4	Cleaning the door glazing	59
4.5	Vapor Clean	61
4.6	Extraordinary maintenance	63
5	Installation	65
5.1	Electrical connection	65
5.2	Instructions for the installer	65
5.3	Cable replacement	66
5.4	Positioning	66

We advise you to read this manual carefully, which contains all the instructions for maintaining the appliance's aesthetic and functional qualities.

For further information on the product: www.smeg.com



1 Instructions

1.1 General safety instructions

Risk of personal injury

- During use the appliance and its accessible parts become very hot. Never touch the heating elements during use.
- Protect your hands by wearing oven gloves when moving food inside the oven.
- Never try to put out a fire or flames with water: Turn off the appliance and smother the flames with a fire blanket or other appropriate cover.
- This appliance may be used by children aged at least 8 and by people of reduced physical, sensory or mental capacity, or lacking in experience in the use of electrical appliances, provided that they are supervised or instructed by adults who are responsible for their safety.
- Children must not play with the appliance.
- Keep children under the age of eight at a safe distance unless they are constantly supervised.
- Keep children under the age of 8 away from the appliance when it is in use.
- Cleaning and maintenance must not be carried out by unsupervised children.
- The cooking process must always be monitored. A short cooking process must be continuously monitored.
- Never leave the appliance unattended during cooking operations where fats or oils could be released, as these could then heat up and catch fire. Be very careful.
- Do not pour water directly onto very hot trays.
- Keep the oven door closed during cooking.
- If you need to move food or at the end of cooking, open the door 5 cm for a few seconds, let the steam come out, then open it fully.
- Do not insert pointed metal objects (cutlery or utensils) into the slots in the appliance.
- Switch off the appliance immediately after use.



- DO NOT USE OR STORE FLAMMABLE MATERIALS NEAR THE APPLIANCE.
- DO NOT USE AEROSOLS IN THE VICINITY OF THIS APPLIANCE WHILST IT IS IN USE.
- DO NOT MODIFY THIS APPLIANCE.
- Have qualified personnel carry out installation and assistance interventions according to the standards in force.
- Do not try to repair the appliance yourself or without the intervention of a qualified technician.
- Do not pull the cable to remove the plug.
- Switch off the burners or the electric hot plates of the hob installed above the appliance during the pyrolytic process (where available).
- Do not seat on the appliance.
- Do not use cleaning products containing chlorine, ammonia or bleach on parts made of steel or that have metallic surface finishes (e.g. anodizing, nickel- or chromium-plating).
- Racks and trays should be inserted as far as they will go into the side guides. The mechanical safety locks that prevent them from being removed must face downwards and towards the back of the oven cavity.
- Do not use steam jets to clean the appliance.
- Do not spray any spray products near the appliance.
- Do not obstruct ventilation openings and heat dispersal slots.
- Never leave objects on the cooking surface.
- DO NOT FOR ANY REASON USE THE APPLIANCE AS A SPACE HEATER.

Risk of damaging the appliance

- Do not use abrasive or corrosive detergents (e.g. scouring powders, stain removers and metallic sponges) on glass parts. Use wooden or plastic utensils.
- Do not use rough or abrasive materials or sharp metal scrapers.



Instructions

- Do not use plastic cookware or containers when cooking food.
- Do not put sealed tins or containers in the oven.
- Remove all trays and racks which are not required during cooking.
- Do not cover the bottom of the oven cavity with aluminium or tin foil sheets.
- Do not place pans or trays directly on the bottom of the oven cavity.
- If you wish to use greaseproof paper, place it so that it will not interfere with the hot air circulation inside the oven.
- Do not use the open door to rest pans or trays on the internal glass pane.
- Never use the oven door to lever the appliance into place when fitting.
- Avoid exerting too much pressure on the oven door when open.
- Do not use the handle to lift or move the appliance.

Installation and maintenance

- THIS APPLIANCE **MUST NOT BE INSTALLED** IN BOATS OR CARAVANS.
- The appliance must not be installed on a pedestal.
- Position the appliance into the cabinet cut-out with the help of a second person.
- To avoid potential overheating, the appliance must not be installed behind a decorative door or a panel.
- Have qualified personnel carry out installation and assistance interventions according to the standards in force.
- Have the electrical connection performed by authorised technical personnel.
- The appliance must be connected to earth in compliance with electrical system safety standards.
- Use cables withstanding a temperature of at least 90 °C.
- The tightening torque of the screws of the terminal supply wires must be 1.5 - 2 Nm.



- If the power supply cable is damaged, contact technical support immediately and they will replace it.
- Always use any necessary/required personal protective equipment (PPE) before performing any work on the appliance (installation, maintenance, positioning or movement).
- Before performing any work on the appliance, switch off the power supply.
- This appliance can be used up to a maximum altitude of 4,000 metres above sea level.

For this appliance

- Take care because steam may not be visible at certain temperatures.
- Open the appliance door carefully during or after cooking.
- Dishes must be heat and steam resistant.
- Ensure that the appliance is switched off before replacing the bulb.
- Do not rest any weight or sit on the open door of the appliance.
- Take care that no objects are stuck in the doors.
- Do not install / use the appliance outdoors.

1.2 Appliance purpose

- This appliance is intended for cooking food in the home environment. Every other use is considered improper.
- The appliance is not designed to operate with external timers or with remote-control systems.



Instructions

1.3 Manufacturer's liability

The manufacturer declines all liability for damage to persons or property caused by:

- Use of the appliance other than that specified
- Failure to comply with the instructions in the user manual
- Tampering with any part of the appliance
- The use of non-original spare parts.

1.4 This user manual

This user manual is an integral part of the appliance and must therefore be kept in its entirety and within the user's reach for the whole working life of the appliance.

Read this user manual carefully before using the appliance.

1.5 Identification plate

The identification plate bears the technical data, serial number and brand name of the appliance. Do not remove the identification plate for any reason.

1.6 Disposal



This appliance must be disposed of separately from other waste (Directives 2002/95/EC, 2002/96/EC, 2003/108/EC). The appliance does not contain substances in quantities sufficient to be considered hazardous to health and the environment, in accordance with current European directives.

To dispose of the appliance:

- Cut the power supply cable and remove it along with the plug.



Power voltage

Danger of electrocution

- Disconnect the mains power supply.
- Unplug the appliance.
- Deliver the appliance to the appropriate recycling centre for electrical and electronic equipment waste, or return it to the retailer when purchasing an equivalent product, on a one for one basis.



Our appliances are packaged in non-polluting and recyclable materials.

- Deliver the packing materials to the appropriate recycling centre.



Plastic packaging Danger of suffocation

- Do not leave the packaging or any part of it unattended.
- Do not let children play with the plastic bags.

1.7 How to read the user manual

This user manual uses the following reading conventions:

Instructions



General information on this user manual, on safety and final disposal.

Description



Description of the appliance and its accessories.

Use



Information on the use of the appliance and its accessories, cooking advice.

Cleaning and maintenance



Information for proper cleaning and maintenance of the appliance.

Installation



Information for the qualified technician: Installation, operation and inspection.



Safety instructions



Information



Advice

1. Sequence of instructions for use.

- Standalone instruction.



Description

2 Description

2.1 General Description

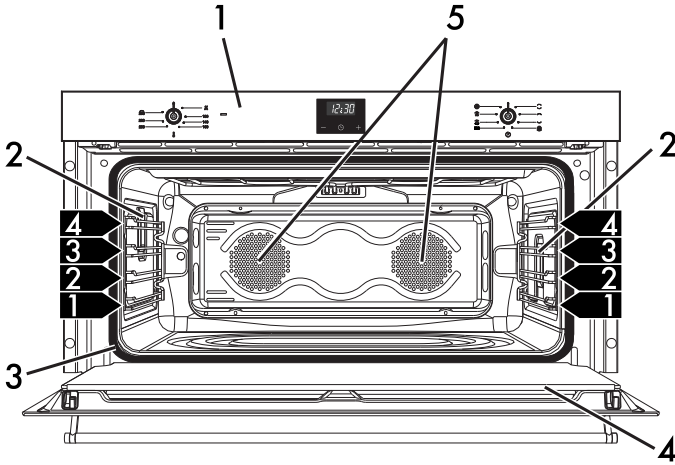

1 Control panel

2 Inside lights

3 Seal

4 Door

5 Fans

1,2,3 Frame shelf



2.2 Control panel

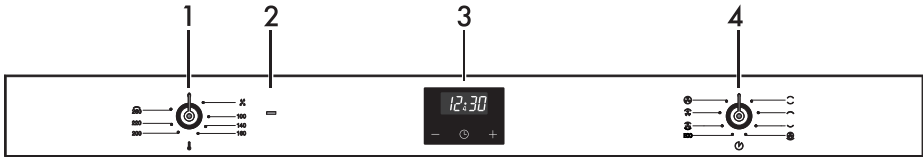

1 Temperature knob

This knob allows you to select the cooking temperature.

Turn the knob clockwise to the required value, between the minimum and maximum setting.

3 Programmer clock

Useful for displaying the current time, setting programmed cooking operations and programming the minute minder timer.

2 Thermostat indicator light

The indicator light comes on to indicate that the oven is heating up. It turns off as soon as it reaches the set temperature. It will then turn on and off regularly, indicating that the temperature set inside the oven is being kept constant.

4 Function knob

This knob allows you to turn the appliance on and off and select the various available functions.

Turn the knob right or left to change/select the required item.



Keep the knob pressed in for at least 5 seconds to immediately complete any cooking operation.

2.3 Other parts

Shelves

The appliance features shelves to position trays and racks at different heights. The insertion heights are indicated from the bottom upwards (see 2.1 General Description).

Cooling fan

The fan cools the appliance and comes into operation during cooking.

The fan causes a steady outflow of air from above the door which may continue for a brief period of time even after the appliance has been turned off.

Interior lighting

The appliance's interior lighting comes on:

- When the door is opened.
- When any function is started, apart from the ECO and Vapor Clean  functions (on some models only).
- When the temperature knob is briefly turned to the right (manual activation and deactivation).



When the door is open, it is not possible to turn off the interior lighting.



Description

2.4 Available accessories

Tray rack

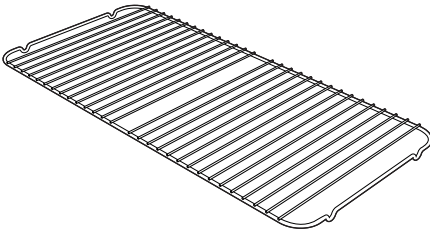

To be placed over the top of the oven tray; for cooking foods which may drip.

Deep tray

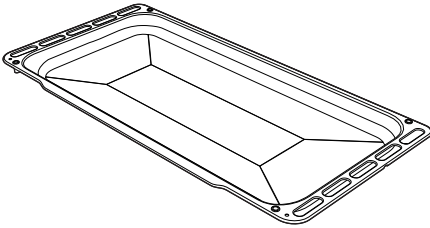

Useful for collecting fat from foods placed on the rack above and for cooking pies, pizzas and baked desserts.

Rack

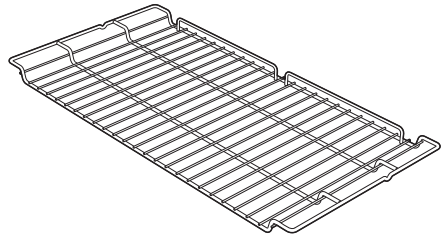

Useful for supporting containers with food during cooking.

i Some models are not provided with all accessories.

i The accessories intended to come into contact with food are made of materials that comply with the provisions of current legislation.

i Supplied and optional accessories can be requested to Authorised Assistance Centres. Use only original accessories supplied by the manufacturer.



3 Use

3.1 Instructions



Improper use Risk of damage to surfaces

- Do not cover the bottom of the oven cavity with aluminium or tin foil sheets.
- If you wish to use greaseproof paper, place it so that it will not interfere with the hot air circulation inside the oven.
- Do not place pans or trays directly on the bottom of the oven cavity.
- Do not pour water directly onto very hot trays.



High temperature inside the oven during use Danger of burns

- Keep the oven door closed during cooking.
- Protect your hands by wearing oven gloves when moving food inside the oven.
- Do not touch the heating elements inside the oven.
- Do not pour water directly onto very hot trays.
- Do not allow children to approach the appliance when it is in operation.



High temperature inside the oven during use Danger of fire or explosion

- Do not spray any spray products near the appliance.
- Do not use or leave flammable materials near the appliance.
- Do not use plastic cookware or containers when cooking food.
- Do not put sealed tins or containers in the oven.
- Do not leave the appliance unattended during cooking operations where fats or oils could be released.
- Remove all trays and racks which are not required during cooking.

3.2 First use

1. Remove any protective film from the outside or inside of the appliance, including accessories.
2. Remove any labels (apart from the technical data plate) from the accessories and from the oven cavity.
3. Remove and wash all the appliance accessories (see 4 Cleaning and maintenance).
4. Heat the empty oven at the maximum temperature to burn off any residues left by the manufacturing process.



Use

3.3 Using the accessories

Tray rack

The tray rack has to be inserted into the tray. In this way fat can be collected separately from the food which is being cooked.

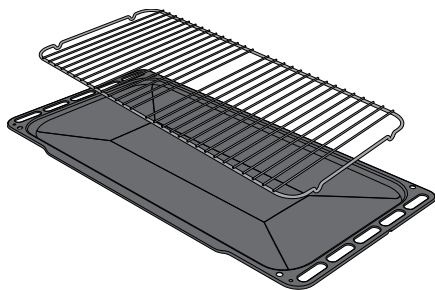

Racks and trays

Racks and trays have to be inserted into the side guides until they come to a complete stop.

The mechanical safety locks that prevent the rack from being removed accidentally must face downwards and towards the back of the oven cavity.

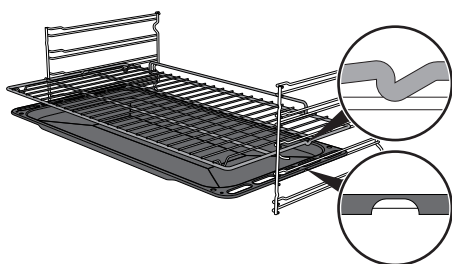

3.4 Using the oven

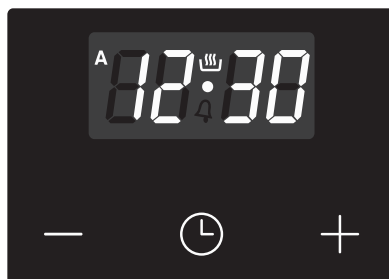

Programmer clock



 Value decrease key

 Clock key

 Value increase key

 Ensure that the programmer clock shows the cooking duration symbol , otherwise it will not be possible to turn on the oven.

Press the  key to reset the programmer clock.



Gently insert racks and trays into the oven until they come to a stop.







Clean the trays before using them for the first time to remove any residues left by the manufacturing process.





Setting the time

i If the time is not set, the oven will not switch on.









On the first use, or after a power failure, the digits  will be flashing on the appliance's display.



1. Hold down the clock key  for two seconds. The dot between the hours and the minutes flashes.
2. The time can be set via the value increase key  and value decrease key . Keep the key pressed in to increase or decrease rapidly.
3. Wait 7 seconds. The dot between the hours and the minutes stops flashing.
4. The  symbol on the display indicates that the appliance is ready to start cooking.

 To change the time, hold down the value increase key  and value decrease key  at the same time for two seconds, then set the time.

Timed cooking

i Timed cooking is the function which allows a cooking operation to be started and then ended after a specific length of time set by the user.

1. Keep the clock key  pressed until the  symbol appears.
2. Press the clock key  again. On the display the symbol  and the text  appear, alternating with the current time.
3. Use the value increase  and value decrease  keys to set the required minutes of cooking.
4. Select a function and a cooking temperature.
5. Wait approx. 5 seconds without pressing any key in order for the function to activate. The current time and the  and  symbols will appear on the display.

At the end of cooking the heating elements will be deactivated. On the display, the  symbol turns off, the  symbol flashes and the buzzer sounds.

6. To turn the buzzer off, simply press one of the programmer clock keys.



Use

- Press the clock key to reset the programmer clock.

i It is not possible to set a cooking time of more than 10 hours.

To cancel the set programming press and hold down the value increase and the value decrease keys at the same time and then turn the oven off manually.

Programmed cooking

i Programmed cooking is the function which allows a cooking operation to be started at a set time and then ended after a specific length of time set by the user.

- Set the cooking time as described in the previous point "Timed cooking".
- Hold the menu key down for 2 seconds.
- Press the menu key again. The display will show the digits and the text in sequence, while the symbol flashes (for example, the current time is 17:30).

- Press the or key to set the required minutes.(for example 1 hour).



- Press the menu key . The text will appear on the display in sequence with the pre-set cooking duration added to the current time (for example, the cooking end time shown is 18:30).

- Press the or key to set the cooking end time (for example, 19:30).

Bear in mind that a few minutes for oven preheating must be added to the cooking time.

- Wait approx. 7 seconds without pressing any key in order for the function to activate. The current time appears and the and symbols light up on the display.
- Select a cooking temperature and function.
- At the end of cooking the heating elements will be deactivated. On the display, the symbol turns off, the symbol flashes and the buzzer sounds.



10. Return the function and temperature knobs to **0**.
11. To turn off the buzzer just press any key of the programmer clock.
12. Press the  and  keys at the same time to reset the set program.





It is not possible to set a cooking time of more than 10 hours.



It is not possible to set a programmed cooking time of more than 24 hours.











After setting, hold the menu key  down for 2 seconds to display the cooking time remaining. Press the menu key  again. The display shows the text  and the remaining cooking time in sequence.

Minute minder timer



The minute minder timer does not stop the cooking operation but rather informs the user when the set time has run out.

The minute minder timer can be activated at any time.

1. Keep the clock key  pressed for per a few seconds. The display shows the figures  and the  symbol flashing between the hours and minutes.
 2. Use the value increase  and value decrease  keys to set the number of minutes required.
 3. Wait approx. 5 seconds without pressing any key to finish setting the minute minder. The current time and the  and  symbols appear on the display.
- A buzzer will sound when the set time is reached.
4. Press the value decrease key  to turn the buzzer off.





The minute minder timer can be set from 1 minute to a maximum of 23 hours and 59 minutes.





Use

Modifying the set data



1. Press the clock key .
2. Use the value increase  and value decrease  keys to set the number of minutes required.

Deleting the set data

1. Press the clock key .
2. Hold down the value increase  and value decrease  keys at the same time.
3. Then switch off the oven manually if cooking is in progress.

Selecting the buzzer

The buzzer can have 3 tones.

1. Hold down the value increase  and value decrease  keys at the same time.
2. Press the clock key .

Press the value decrease key  to select a different buzzer tone.

Functions list



Static

As the heat comes from above and below at the same time, this system is particularly suitable for certain types of food. Traditional cooking, also known as static cooking, is suitable for cooking just one dish at a time. Perfect for all types of roasts, bread and cakes, and in any case, particularly suitable for fatty meats such as goose and duck.



Grill

The heat coming from the grill element gives perfect grilling results above all for thin and medium thickness meat and, in combination with the rotisserie (where fitted), gives the food an even browning at the end of cooking. Perfect for sausages, spare ribs and bacon. This function enables large quantities of food, particularly meat, to be grilled evenly.



Lower element

The heat coming just from the bottom allows you to complete the cooking of foods that require a higher bottom temperature, without affecting their browning. Perfect for cakes, pies, tarts and pizzas.



Lower element + fan with circulaire

Fan assisted cooking is combined with the heat coming from below and allows you to brown food slightly at the same time. Perfect for any type of food



Fan with grill

The air produced by the fan softens the strong heatwave generated by the grill, grilling perfectly even very thick foods. Perfect for large cuts of meat (e.g. shin of pork).

ECO

ECO

This function is particularly suitable for cooking on a single shelf with low energy consumption.

Ideal for cooking meat, fish and vegetables. It is not recommended for leavened foods.

To obtain maximum energy savings and reduce cooking times, it is recommended to place food in the oven without preheating.



Cooking (and preheating) times are longer with the ECO function.



When using the ECO function, avoid opening the door during cooking.



Fan assisted

The operation of the fan, combined with traditional cooking, ensures consistent cooking even with complex recipes. Perfect for biscuits and cakes, even when simultaneously cooked on several levels. (For multiple-level cooking, we recommend using the 2nd and 4th shelf).



Fan with circulaire

The combination of the fan and the circulaire heating element (incorporated in the rear of the oven) allows you to cook different foods on several levels, as long as they need the same temperatures and same type of cooking. Hot air circulation ensures instant and even distribution of heat. It will be possible, for instance, to cook fish, vegetables and biscuits simultaneously (on different levels) without odours and flavours mingling.



3.5 Cooking advice

General advice

- Use a fan assisted function to achieve consistent cooking at several levels.
- It is not possible to shorten cooking times by increasing the temperature (the food could be overcooked on the outside and undercooked on the inside).
- For the same total weight, cooking time will be greater for cooking a whole piece than when it is cut into smaller pieces.

Advice for cooking meat

- Cooking times vary according to the thickness and quality of the food and to consumer taste.
- Use a meat thermometer when roasting meat, or simply press on the roast with a spoon. If it is hard, it is ready; If not, it needs another few minutes cooking.

Advice for cooking with the Grill

- Meat can be grilled even when it is put into the cold oven or into the preheated oven if you wish to change the effect of the cooking.
- With the Fan with grill function, we recommend that you preheat the oven before grilling.
- We recommend placing the food at the centre of the rack.

Advice for cooking desserts/pastries and biscuits

- Use dark metal moulds: They help to absorb the heat better.
- The temperature and the cooking time depend on the quality and consistency of the dough.
- When cooking on multiple levels, food should ideally be positioned on the second and fourth shelves; increase cooking time by a few minutes and only used fan functions.
- To check whether the dessert is cooked right through: At the end of the cooking time, put a toothpick into the highest point of the dessert. If the dough does not stick to the toothpick, the dessert is cooked.
- If the dessert collapses when it comes out of the oven, on the next occasion reduce the set temperature by about 10°C, selecting a longer cooking time if necessary.
- The cooking time for meringues and choux pastry will vary depending on the size.



Advice for defrosting and proving

- Place frozen foods without their packaging in a lidless container on the first shelf of the oven.
- Avoid overlapping the food.
- To defrost meat, use the rack placed on the second level and a tray on the first level. In this way, the liquid from the defrosting food drains away from the food.
- Bread and fruit, if divided into pieces, will take the same amount of time to defrost, regardless of the total weight and quantity.
- The most delicate parts can be covered with aluminium foil.
- For successful proving, a container of water should be placed in the bottom of the oven.

To save energy

- Stop cooking a few minutes before the time normally used. Cooking will continue for the remaining minutes with the heat which has accumulated inside the oven.
- Reduce any opening of the door to a minimum to avoid heat dispersal.
- Keep the inside of the appliance clean at all times.



Use

Cooking information table

Food	Weight (Kg)	Function	Shelf	Temperature (°C)	Time (minutes)	
Lasagne	2	Static	1	230	40 - 45	
Pasta bake	2	Static	1	220	40 - 45	
MEAT						
Veal roast	2 - 2.5	Fan assisted	2	180	115 - 125	
Pork loin	2	Fan assisted	2	180	80 - 85	
Roast beef: medium	2	Circulaire	2	200	80 - 85	
Roast rabbit (pieces)	1	Circulaire	2	180	70 - 75	
Turkey breast	1.5	Fan assisted	2	180 - 190	80 - 90	
Roast pork neck	2	Circulaire	2	180 - 190	150 - 160	
Roast chicken	1.5	Circulaire	2	200	70 - 75	
GRILLING (*)					1st side 2nd side	
Sausages	0.5 - 1	Fan with grill	3	max	9	5
Pork chops (200 g each)	tot. 1.5	Grill	4	max	17	6
Spare ribs (attached)	1	Fan with grill	3	max	13	7
Bacon (0.5 mm thick)	0.8 - 1	Fan with grill	3	max	8	3
Pork fillet (0.5 mm thick)	0.8 - 1	Grill	4	max	15	4
Beef fillet (2 cm thick)	0.8 - 1	Grill	4	max	6	4
WHOLE FISH						
Salmon trout	0.5	Fan assisted	2	160	40 - 45	
Monkfish	0.7	Fan with circulaire	2	160	65 - 70	
Sea bass	0.5	Fan with circulaire	2	160	45 - 50	
VEGETABLES						
Roast potatoes	1.5 - 2	Fan assisted	2	190	35 - 40	
Mixed roasted vegetables	1.5 - 2	Fan assisted	2	190	35 - 38	
Grilled sliced vegetables (**)	0.5mm thick	Grill	4	max	10	7
DOUGH						
Fresh pizza	1.5 - 2	Fan assisted	2	max	12 - 15	
Bread (loaf)	0.4	Fan with circulaire	2	200	30	
Focaccia	1.5	Fan assisted	2	180	25 - 28	



DESSERTS/PASTRIES

Meringue (medium - small)	0.35	Fan with circulaire	2	120	80 - 90
Bundt cake	1.5	Fan with circulaire	2	160	55 - 60
Jam tart	1	Static	2	170	35 - 40
Ricotta cake	1.2	Static	2	180	45-50
Muffins	40 g each	Fan assisted/Fan with circulaire	2	160	25 - 30
Paradise cake	1.2	Fan with circulaire	2	160	55 - 60
Profiteroles (medium - small)	dough 0.5	Fan with circulaire	2	180	70 - 75
Sponge cake	1	Fan with circulaire	2	150	55 - 60
Biscuits (0.5 mm thick)	dough 0.5	Fan assisted	2	160	14 - 16
Brioches	0.6	Fan assisted	2	160	30 - 35

The times indicated in the table do not include preheating times and are provided only as a guide. (*) Grilling times depend on the thickness of the food and the level of cooking/browning you wish to achieve.

(***) The times for grilled vegetables may vary depending on the thickness of the food and the type of vegetable.

Roast meats should be turned during cooking to achieve uniform browning on all sides.



Cleaning and maintenance

4 Cleaning and maintenance

4.1 Instructions



**Improper use
Risk of damage to surfaces**

- Do not use steam jets to clean the appliance.
- Do not use cleaning products containing chlorine, ammonia or bleach on parts made of steel or that have metallic surface finishes (e.g. anodizing, nickel- or chromium-plating).
- Do not use abrasive or corrosive detergents (e.g. scouring powders, stain removers and metallic sponges) on glass parts.
- Do not use rough or abrasive materials or sharp metal scrapers.

4.2 Cleaning the appliance



We recommend the use of cleaning products distributed by the manufacturer.

Recommendations for cleaning the oven cavity

In order to keep your oven in the best possible condition, clean it regularly after letting it cool down.

Avoid letting food residue dry inside the oven cavity, as this could damage the enamel.

Take out all removable parts before cleaning.

For easier cleaning, we recommend removing:

- The door
- The rack/tray support frames
- The oven seal.



In the event you are using specific cleaning products, we recommend running the oven at maximum temperature for 15-20 minutes in order to eliminate any residue.

4.3 Removing the door

For easier cleaning it is recommended to remove the door and place it on a tea towel.

To remove the door proceed as follows:

1. Open the door completely and insert two pins into the holes on the hinges indicated in the figure.

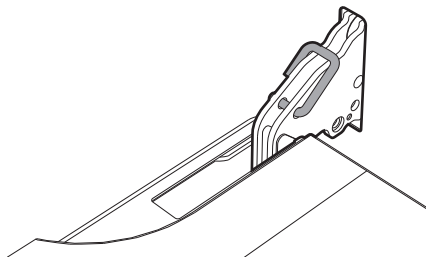



2. Grasp the door on both sides with both hands, lift it so that it forms an angle of around 30° and remove it.

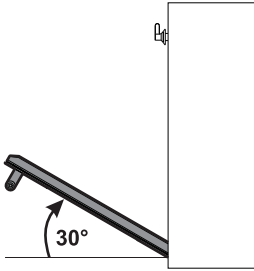

3. To reassemble the door, put the hinges in the relevant slots in the oven, making sure that grooved sections **A** are resting completely in the slots. Lower the door and once it is in place remove the pins from the holes in the hinges.

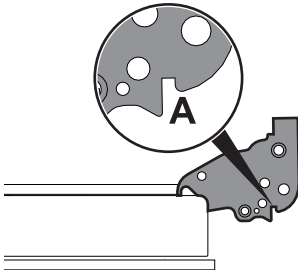

4.4 Cleaning the door glazing

The glass in the door should always be kept thoroughly clean. Use absorbent kitchen roll. In case of stubborn dirt, wash with a damp sponge and an ordinary detergent.



We recommend the use of cleaning products distributed by the manufacturer.

Removing the internal glass panes

For easier cleaning the internal glass panes of the door can be removed.

1. Remove the door of the appliance or lock it in position using the special pins.
2. Remove the internal glass pane by pulling the rear part gently upwards, following the movement indicated by the arrows.

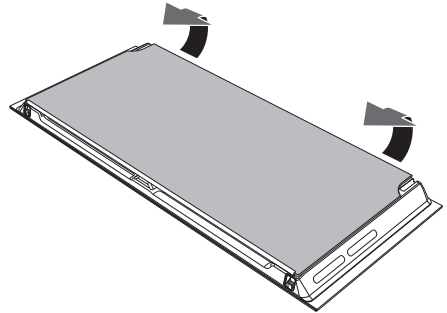



Cleaning and maintenance

3. Then remove the internal glass pane from the front profile.

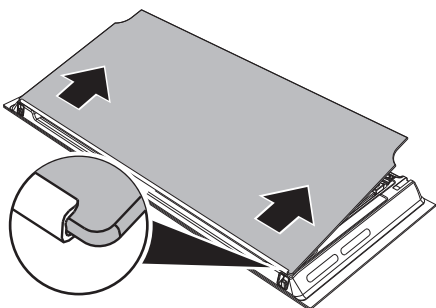

4. Remove the intermediate glass unit by lifting it upwards.

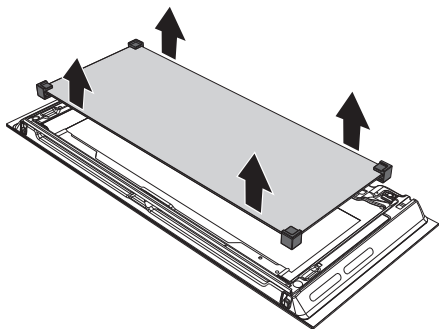

5. Clean the external glass pane and the panes removed previously. Use absorbent kitchen roll. In case of stubborn dirt, wash with a damp sponge and neutral detergent.

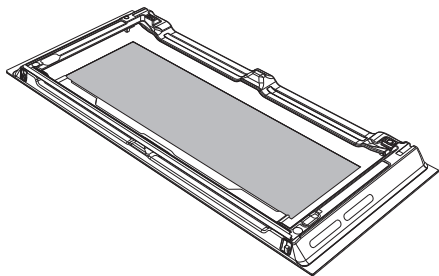

6. Reposition the intermediate glass unit.

7. Reposition the internal glass pane. Insert the front part into the front profile (1). Then lower the rear part and insert the pins into their housings on the door by applying slight pressure (2).

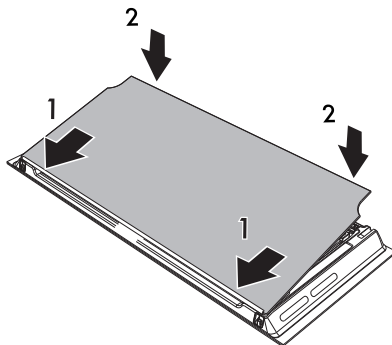

Removing rack/tray support frames

Removing the rack/tray support frames enables the sides to be cleaned more easily.

To remove the rack/tray support frames:

- Pull the frame towards the inside of the oven to unhook it from its groove **A**, then slide it out of the seats **B** at the back.

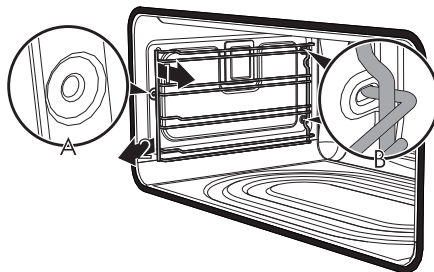

- When cleaning is complete, repeat the above procedures to put the rack/tray support frames back in.



4.5 Vapor Clean



Vapor Clean is an assisted cleaning procedure which facilitates the removal of dirt. Thanks to this process, it is possible to clean the inside of the oven very easily. The dirt residues are softened by the heat and water vapour for easier removal afterwards.



Improper use
Risk of damage to surfaces

- Remove any food residues or large spills from previous cooking operations from the inside of the oven.
- Carry out assisted oven cleaning operations only when the oven is cold.

Preliminary operations

Before starting the Vapor Clean function:

- Completely remove all accessories from inside the oven.
- Remove the rack/tray support frames.
- Detach removable guides, where fitted.
- Close the door.

- Pour approximately 400 cc of water into the tray. Make sure it does not overflow out of the cavity.

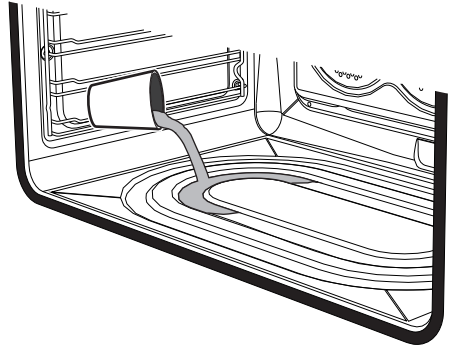

- Spray a water and washing up liquid solution inside the oven using a spray nozzle. Direct the spray towards the side walls, upwards, downwards and towards the deflector.

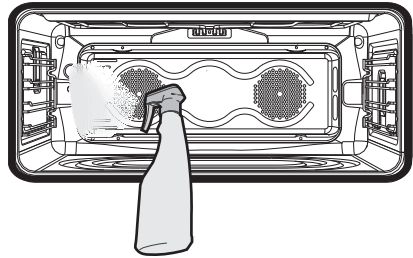

- Close the door.





We recommend spraying approx. 20 times at the most.



Cleaning and maintenance

Vapor Clean cycle setting

1. Set a cooking time of 18 minutes using the programmer clock.
2. Turn the function knob on the  symbol.
3. Turn the temperature knob to the  symbol.

The Vapor Clean cycle starts a few seconds after the last press on the programmer clock keys.

4. At the end of the Vapor Clean cycle, the timer will deactivate the oven heating elements, the buzzer will sound and the numbers on the programmer clock will flash.

End of the Vapor Clean cycle

5. Open the door and wipe away the less stubborn dirt with a microfibre cloth.
6. Use a non-scratch sponge with brass filaments on hard to remove deposits.
7. In case of grease residues use specific oven cleaning products.
8. Remove the water left inside the oven.

For improved hygiene and to avoid food being affected by any unpleasant odours, we recommend that the oven is dried using a fan assisted function at 160°C for approximately 10 minutes.



We recommend wearing rubber gloves for these operations.



We recommend removing the door in order to make the manual cleaning of the parts that are difficult to reach easier.



4.6 Extraordinary maintenance

Installing and removing the seal

To remove the seal:

- Unhook the clips located in the 4 corners and in the centre, then pull the seal outwards.

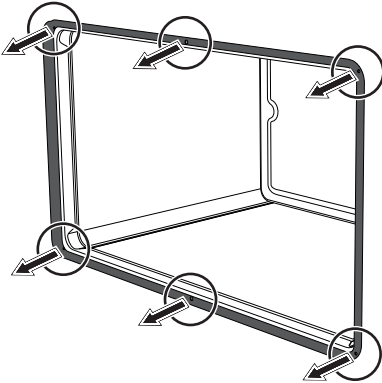

To refit the seal:

- Hook the clips located in the 4 corners and in the centre onto the gasket.

Seal maintenance tips

The seal should be soft and elastic.

- To keep the seal clean, use a non-abrasive sponge and wash with lukewarm water.

Replacing the internal light bulb



Live parts

Danger of electrocution

- Unplug the appliance.



The oven is fitted with two 40W light bulbs.

1. Completely remove all accessories from inside the oven.
2. Remove the rack/tray support frames.
3. Remove the bulb cover using a tool (e.g. a screwdriver).



Pay attention not to scratch the oven cavity enamel.

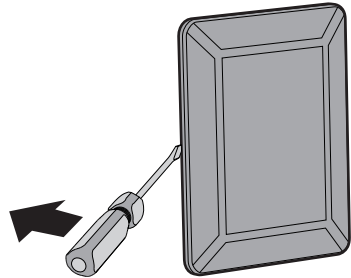



Cleaning and maintenance

- Slide out and remove the light bulb.

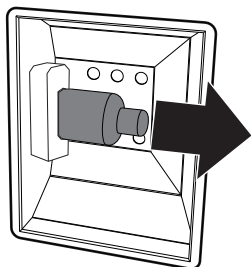

Do not touch the halogen light bulb directly with your fingers, but wrap it in insulating material.

- Fit the new light bulb.
- Refit the cover. Ensure the moulded part of the glass (**A**) is facing the door.

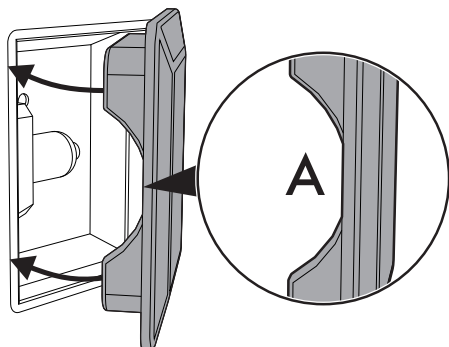

- Press the cover completely down so that it attaches perfectly to the bulb support.



5 Installation

5.1 Electrical connection



Power voltage
Danger of electrocution

- Have the electrical connection performed by authorised technical personnel.
- The appliance must be connected to earth in compliance with electrical system safety standards.
- Disconnect the mains power supply.

General information

Check the grid characteristics against the data indicated on the plate.

The identification plate bearing the technical data, serial number and brand name is visibly positioned on the appliance.

Do not remove this plate for any reason.

The appliance operates at 220-240 V~.

Use a three-core cable (3 x 1.5 mm² internal conductors).

Perform the ground connection using a wire that is 20 mm longer than the other wires.

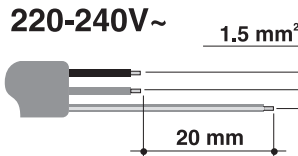

Fixed connection

Fit the power line with an all-pole circuit breaker in compliance with installation regulations.

The circuit breaker should be located near the appliance and in an easily reachable position.

Connection with plug and socket

Make sure that the plug and socket are of the same type.

Avoid using adapters and shunts as these could cause overheating and a risk of burns.

5.2 Instructions for the installer

- The plug must be accessible after installation. Do not bend or trap the power cable.
- The appliance must be installed according to the installation diagrams.
- If the appliance does not work correctly after having carried out all the checks, contact your local Authorised Service Centre.
- Once the appliance has been installed, please explain to the user how to use it correctly.



Installation

5.3 Cable replacement



**Power voltage
Danger of electrocution**

- Disconnect the mains power supply.

1. Unscrew the 6 screws on the rear casing.

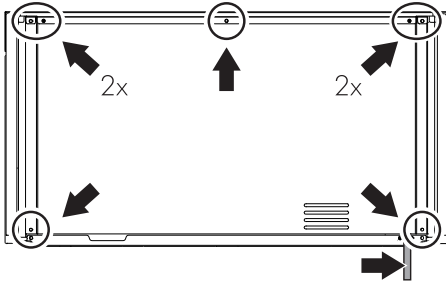

**Position of the screws and the power cable
(rear view)**

2. Lift the rear casing slightly and remove it to gain access to the terminal board.
3. Replace the cable.
4. Make sure that the cables (for the oven or any hob) follow the best route in order to avoid any contact with the appliance.

5.4 Positioning



**Heavy appliance
Crushing hazard**

- Position the appliance into the cabinet cut-out with the help of a second person.



**Pressure on the open door
Risk of damage to the appliance**

- Never use the oven door to lever the appliance into place when fitting.
- Avoid exerting too much pressure on the oven door when open.



**Heat production during appliance operation
Risk of fire**

- Check that the carcass material is heat resistant.
- Check that the carcass has the required openings.
- Do not install the appliance in a recess which can be closed with a door, or in a cupboard.



Removing the rear cable clamp

Before inserting the appliance, the cable clamp on the rear casing should be removed using a pair of scissors or a specific tool.

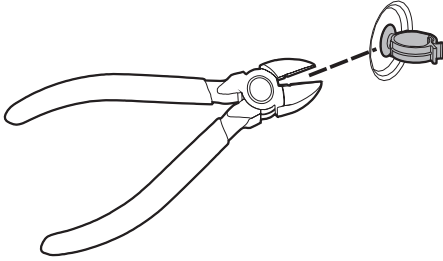

Front panel seal

When installing under a worktop, the seal provided must be glued to the back of the front panel to prevent water or other liquids leaking in from the worktop above.

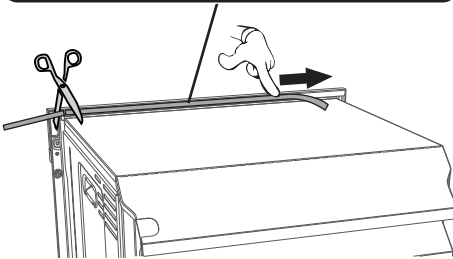

Install a wooden bar underneath the worktop.

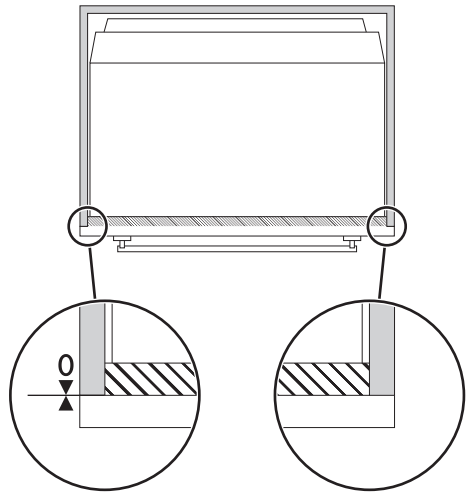
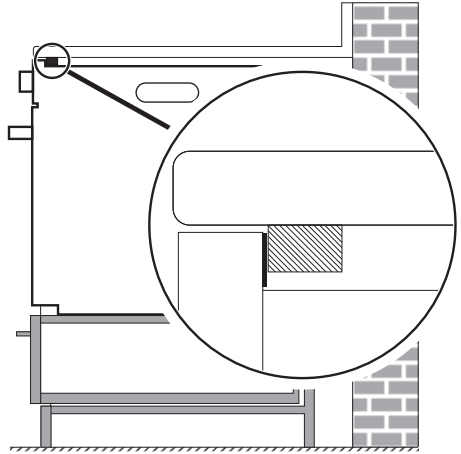

EN



Installation

Fastening bushings

1. Remove the bushing covers on the front of the oven.

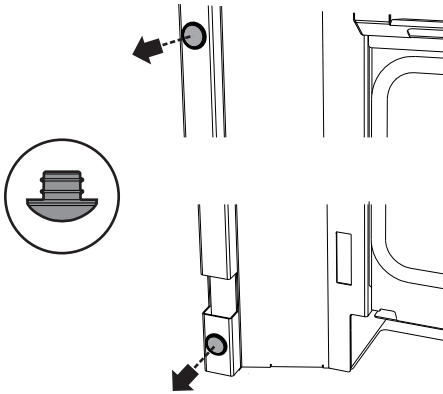

4. Cover the bushings with the previously removed covers.

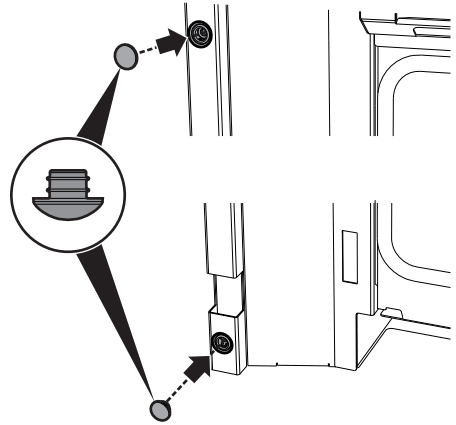

2. Mount the appliance into the recess.
3. Secure the appliance to the carcass using the screws.

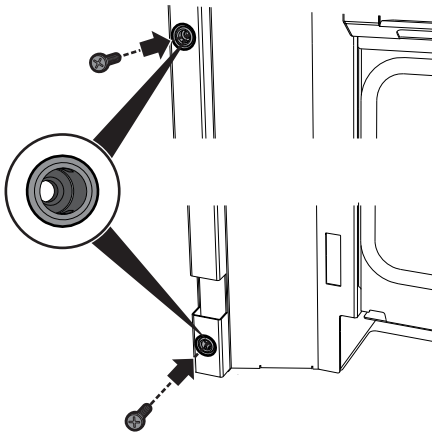

Appliance overall dimensions (mm)

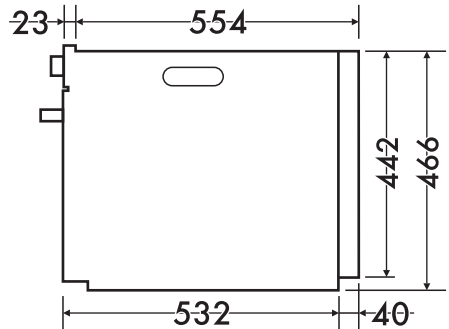
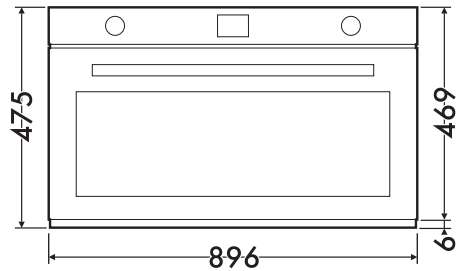

Installation



Mounting under worktops (mm)

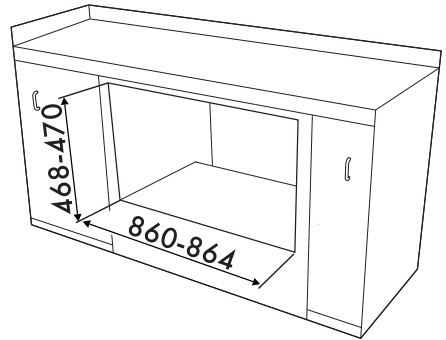
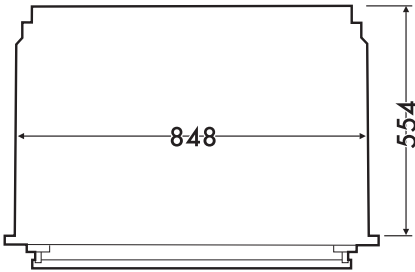

EN

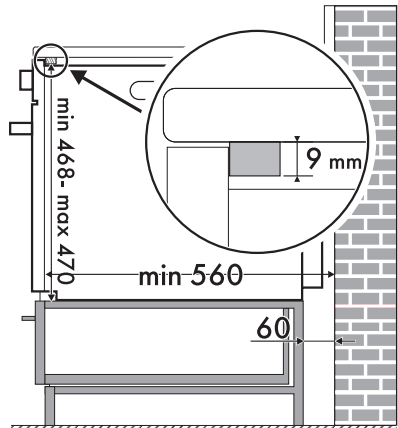
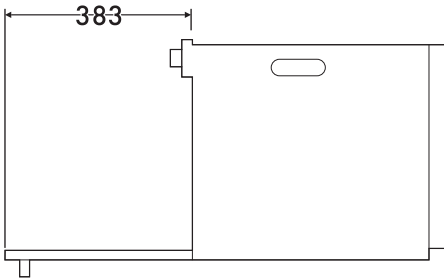
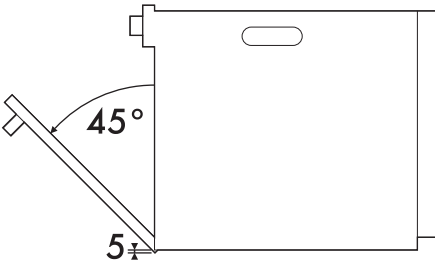

Make sure that the carcass rear/
bottom section has an opening of
approx. 60 mm.



Installation

Mounting into a column (mm)

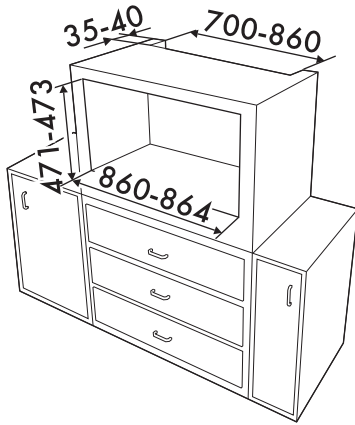

Make sure that the carcass top/
rear section has an opening
approx. 35-40 mm deep.

