

SFP9302TX



Category	90cm
Product Family	Oven
Power supply	Electric
Heat source	ELECTRICITY
Cooking method	Thermo-ventilated
Cleaning system	Pyrolitic
EAN code	8017709325466



Aesthetics

Aesthetic	Classica	Serigraphy type	Symbols
Colour	Stainless steel	Door	With 2 horizontal strips
Finishing	Fingerproof	Handle	Classic
Design	Flat	Handle Colour	Inox
Material	Stainless steel	Logo	Embossed
Type of steel	Brushed	Control knobs	Classic
Glass Type	Eclipse	Controls colour	Steel effect
Serigraphy colour	Black		

Controls

			
Display name	EvoScreen	Control setting	Knobs & touch buttons
Display technology	LCD	No. of controls	2

Programme / Functions

No. of cooking functions	10
---------------------------------	----

Traditional cooking functions

 Static	 Fan assisted	 Circulaire
 Turbo	 Eco	 Large grill
 Fan grill (large)	 Base	 Circulaire + bottom
 Pizza		

Other functions

 Defrost by time	 Leavening	 Stone cooking
 BBQ	 Air-Fry	 Sabbath

Cleaning functions

 Pirolysis
--

Options



Time-setting options	Delay start and automatic end cooking	Other options	Keep warm, Eco light, Brightness, Tones
Minute minder	Yes	Showroom demo option	Yes
Controls Lock / Child Safety	Yes	Rapid pre-heating	Yes

Technical Features



Minimum Temperature	30 °C	Heating suspended when door is opened	Yes
Maximum temperature	280 °C	Door opening type	Standard opening
No. of shelves	5	Door	Temperate door
N. of fans	3	Removable door	Yes
No. of lights	2	Full glass inner door	Yes
Light type	Halogen	Removable inner door	Yes
User-replaceable light	Yes	Total no. of door glasses	4
Light Power	40 W	Soft Close hinges	Yes
Light when door is opened	Yes	Cooling system	Tangential
Lower heating element power	1700 W	Cooling duct	Double
Upper heating element - Power	1200 W	Speed Reduction	Yes
Grill element - power	1700 W	Cooling System	
		Usable cavity space dimensions (HxWxD)	371x724x418 mm

Large grill - Power	2900 W	Temperature control	Electronic
Circular heating element - Power	1550 W	Cavity material	Ever clean Enamel
Circular heating element 2 - Power	1550 W		

Performance / Energy Label

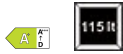

Energy efficiency class	A+	Energy consumption in forced air convection	5.47 MJ
Net volume of the cavity	115 l	Energy consumption per cycle in fan-forced convection	1.52 kWh
Energy consumption per cycle in conventional mode	0.84 kWh	Number of cavities	1
Energy consumption in conventional mode	3.02 MJ	Energy efficiency index	81.6 %

Accessories Included



Rack with back stop	2	Insert grid	1
Enamelled tray (20mm)	1	Telescopic Guide rails, partial Extraction	1
Enamelled deep tray (40mm)	1		

Electrical Connection

Plug	Not present	Voltage 2	380-415 V
Voltage	220-240 V	Frequency (Hz)	50/60 Hz
Current	18 A	Power supply cable length	150 cm
Nominal power	4000 W		

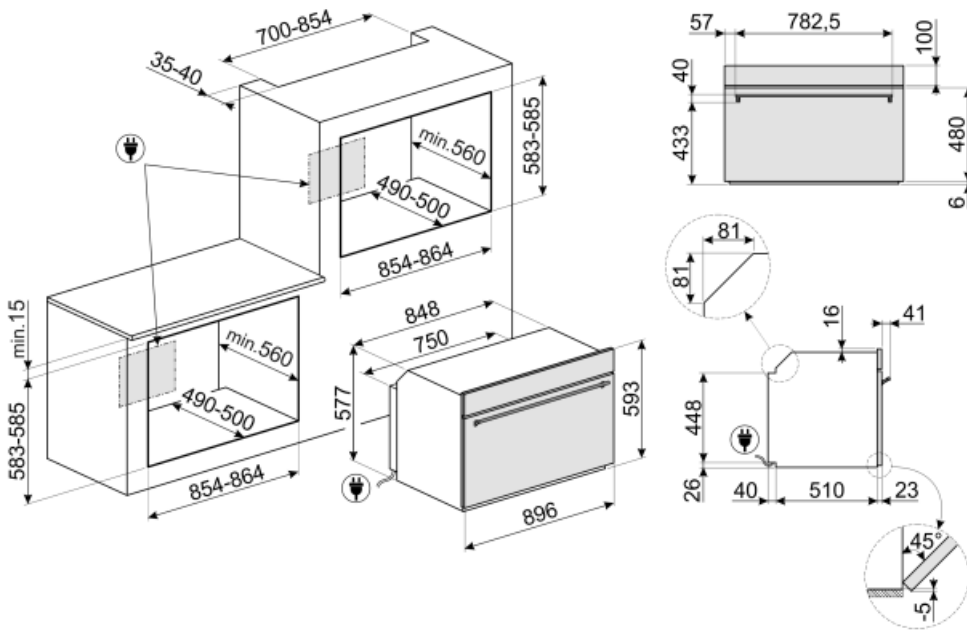

Not included accessories

GTP

Partially extractable telescopic guides (1 level), suitable for traditional ovens. Made in stainless steel, they guarantee stability and facilitate the smooth extraction of the trays.



GTT

Totally extractable telescopic guides (1 level), suitable for traditional ovens. Made in stainless steel, they guarantee stability and facilitate the smooth extraction of the trays.



































PPR9

Refractory pizza stone without handles. Squared shaped stone: L64xH2,3xP37,5 cm Suitable also for gas ovens, to be put on the griddle.



Symbols glossary (TT)

- | | |
|--|--|
|  <p>Triple Fan Technology: The oven is equipped with an exclusive three fan system, which, combined with the increased power of the motors, enables excellent cooking performance. The two large side fans distribute the air around the outer perimeter of the cavity while the smaller central fan increases ventilation by creating a vertical vortex of heat. Accordingly, the temperature within the cavity is uniform, allowing food to be cooked evenly on all five levels, like in professional kitchens.</p> |  <p>Dedicated cooking function for the double sided plate BBQ. Suitable for recreating succulent and crispy dishes in the oven with the typical taste of grilled cooking. The ribbed side is particularly suitable for meats and cheeses; the smooth side for fish, seafood and vegetables.</p> |
|  <p>A+: Energy efficiency class A+ helps to save up to 10% energy compared to class A. Maximum performance with minimum consumption is guaranteed.</p> |  <p>Child lock: some models are fitted with a device to lock the programme/cycle so it cannot be accidentally changed.</p> |
|  <p>Air cooling system: to ensure a safe surface temperatures.</p> |  <p>Defrost by time: Manual defrost function. At the end of the set duration, the function stops.</p> |
|  <p>Quadruple glazed: Number of glazed doors.</p> |  <p>Automatic lighting deactivation: For greater energy savings, the lighting turns off automatically after one minute from the start of cooking. The option can be disabled via the settings menu. In this case the light will remain on for the entire duration of cooking.</p> |
|  <p>Electric</p> |  <p>Ever Clean Enamel: Ever Clean enamel is applied electrostatically, corner to corner and edge to edge to prevent cracking or cracks over time. It is a particular pyrolytic enamel, resistant to acids which, in addition to being pleasantly bright, promotes greater cleaning of the oven walls, thanks to its lower porosity. It is baked at over 850 ° C and slowly polymerized at a scientifically determined rate to ensure uniform depth and strength. Ever Clean enamel creates an impeccable finish both on the inside of the oven and on the trays, making the surfaces of the oven incredibly easy to maintain over time as it reduces the adhesion of fat during cooking.</p> |
|  <p>Fan assisted: Intense and homogeneous traditional cooking, also suitable for complex recipes. The fan is active and the heat comes from below and from above at the same time. Ventilated cooking ensures a faster and more homogeneous result, leaving fragrant foods outside and moister inside. Ideal for baked pasta, biscuits, roasts and cobblers.</p> |  <p>Static: Traditional cooking suitable for the preparation of one dish at a time. The fan is not active and the heat comes from below and from above at the same time. Static cooking is slower and more delicate, ideal in order to get well cooked and dry dishes even inside. Ideal for cooking all types of roasts, fatty meats, bread, filled cakes.</p> |
|  <p>Base: the heat comes only from the bottom of the cavity. The fan is not active. Ideal for sweet and savory pies, cobblers and pizzas. Designed to complete cooking and make food more crunchy. This symbol in gas ovens indicates the gas burner.</p> |  <p>Circulaire with lower element: The addition of the lower element adds extra heat at the base for food which requires extra cooking.</p> |

-  **Circulaire:** it is the perfect function for cooking all types of dishes in a more delicate way. The heat comes from the back of the oven and is distributed quickly and evenly. The fan is active. It is also ideal for cooking on multiple levels without mixing smells and flavors.
-  **Grill:** Very intense heat coming only from above from a double heating element. The fan is not active. Provides excellent grilling and gratinating results. Used at the end of cooking, it gives a uniform browning to dishes.
-  **Pizza function:** Specific function for cooking pizza in a pan. It allows to obtain a pizza that is soft inside and crispy outside with the topping perfectly cooked, not dry and not burnt.
-  **All glass inner door:** All glass inner door, a single flat surface which is simple to keep clean.
-  **KEEP_WARM_72dpi**
-  **PYROLYSIS - AUTOMATIC CLEANING FUNCTION:** the oven heats up to a temperature approaching 500 ° C and chars grease and food residues into a fine ash that can be easily wiped off with a damp cloth. At such a high temperature, the door locks automatically for safety, while the temperature of the door remains controlled so it is safe to touch. User adjustable function based on the level of dirt present in the oven.
-  **Rapid preheating:** cooking is preceded by the preheating phase which allows the cooking compartment to reach the set temperature. This option reduces the time by up to 50%.
-  **The oven cavity has 5 different cooking levels.**
-  **Telescopic rails:** allow you to pull out the dish and check it without having to remove it from the oven entirely.
-  **ECO:** low energy consumption cooking: this function is particularly suitable for cooking on a single shelf with low energy consumption. It is recommended for all types of food except those that can generate a lot of moisture (for example vegetables). To achieve maximum energy savings and reduce time, it is recommended to put the food in the oven without preheating the cooking compartment.
-  **Fan grill:** very intense heat coming only from above from a double heating element. The fan is active. It allows the optimal grilling of thickest meats. Ideal for large cuts of meat.
-  **Turbo:** the heat comes from 3 directions: above, below and from the back of the oven. The fan is active. It allows quick cooking, even on several shelves without mixing the aromas. Ideal for large volumes or foods that require intense cooking.
-  **The inner door glass:** can be removed with a few quick movements for cleaning.
-  **Side lights:** Two opposing side lights increase visibility inside the oven.
-  **Air at 40°C** provides the perfect environment for proving yeast type dough mixes. Simply select the function and place dough in the cavity for allotted.
-  **SABBATH:** function that allows to cook food respecting Judaism's day of rest provisions.
-  **Soft close:** all models are equipped with advanced function of smooth closing of the door, which allows the device to close smoothly and quietly.
-  **Electronic control:** Allows you to maintain temperature inside the oven with the precision 2-3 ° C. This enables to cook meals that are very sensitive to temperature changes, such as cakes, souffles, puddings.



The capacity indicates the amount of usable space in the oven cavity in litres.



The new EVOscreen display is enhanced with new, optimised colour graphics: 5 touch buttons control functions and parameters in an extremely simple way.



Dedicated cooking function for the Air fryer rack AIRFRY . Ideal for recreating traditional frying in the oven, but with fewer calories and less fat. It allows you to cook quickly and simply dishes such as French fries, fried vegetables and fish, ensuring perfect browning and crispiness.



Dedicated cooking function for the rectangular refractory stone PPR2 Dimensions Ideal for cooking pizzas with the same results as a typical wood-fired oven. Can also be used for baking bread, focaccias and other recipes such as pies, flans or biscuits