



EN Freezer - Fridge / User Manual

DE Kühl-Gefrierkombination / Bedienungsanleitung

FR Congélateur - Réfrigérateur / Guide D'utilisation

NL Vriezer - Koelkast / Handleiding

IT Congelatore - Frigorifero / Manuale per l'uso

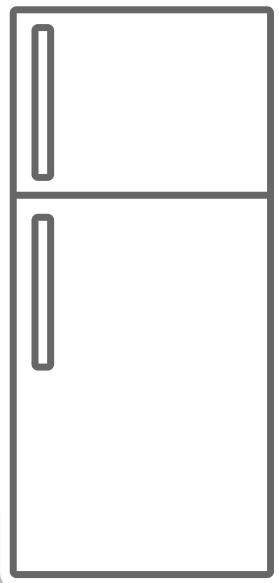





FD84EN4HX

FD84EN4HM

Thank you for choosing this product.

This user manual contains important information on safety and instructions intended to assist you in the operation and maintenance of your appliance.

Please take the time to read this user manual before using your appliance and keep this book for future reference.

Icon	Type	Meaning
	WARNING	Serious injury or death risk
	RISK OF ELECTRIC SHOCK	Dangerous voltage risk
	FIRE	Warning; Risk of fire / flammable materials
	CAUTION	Injury or property damage risk
	IMPORTANT	Operating the system correctly

CONTENTS

1 SAFETY INSTRUCTIONS	4
1.1 General Safety Warnings	4
1.2 Installation warnings	8
1.3 During Usage.....	9
2 DESCRIPTION OF THE APPLIANCE	10
2.1 Dimensions.....	11
3 USING THE APPLIANCE	12
3.1 Information about New Generation Cooling Technology	12
3.2 Display and Control Panel.....	12
3.3 Operating Your Fridge Freezer.....	13
3.3.1 Super Freeze Mode.....	13
3.3.2 Super Cool Mode	13
3.3.3 Economy Mode.....	13
3.3.4 Holiday Mode.....	14
3.3.5 Drink Cool Mode.....	14
3.3.6 Screen Saver Mode.....	14
3.3.7 The Child Lock Function.....	15
3.4 Temperature Settings	15
3.4.1 Freezer Temperature Settings	15
3.4.2 Cooler Temperature Settings.....	16
3.4.3 Door Open Alarm Function	16
3.5 Temperature Adjustment Warnings.....	16
3.6 Accessories	17
3.6.1 The Icematic	17
3.6.2 The Chiller Shelf	17
3.6.3 The Fresh Dial	18
3.6.4 Adjustable Door Shelf.....	18
4 FOOD STORAGE	19
4.1 Refrigerator Compartment.....	19
4.2 Freezer Compartment	20
5 CLEANING AND MAINTENANCE	23
6 SHIPMENT AND REPOSITIONING	24
6.1 Transportation and Changing Positioning	24
6.2 Repositioning the Door.....	24
7 BEFORE CALLING AFTER-SALES SERVICE	25
8 TIPS FOR SAVING ENERGY	27
9 TECHNICAL DATA	28
10 INFORMATION FOR TEST INSTITUTES	28
11 CUSTOMER CARE AND SERVICE	29

1 SAFETY INSTRUCTIONS

1.1 General Safety Warnings

Read this user manual carefully.

⚠ WARNING: Keep ventilation openings, in the appliance enclosure or in the built-in structure, clear of obstruction.

⚠ WARNING: Do not use mechanical devices or other means to accelerate the defrosting process, other than those recommended by the manufacturer.

⚠ WARNING: Do not use electrical appliances inside the food storage compartments of the appliance, unless they are of the type recommended by the manufacturer.

⚠ WARNING: Do not damage the refrigerant circuit.

⚠ WARNING: When positioning the appliance, ensure the supply cord is not trapped or damaged.

⚠ WARNING: Do not locate multiple portable socket-outlets or portable power supplies at the rear of the appliance.

⚠ WARNING: In order to avoid any hazards resulting from the instability of the appliance, it must be fixed in accordance with the instructions.

⚠ If your appliance uses R600a as a refrigerant (this information will be provided on the label of the cooler) you should take care during transportation and installation to prevent the cooler elements from being damaged. R600a is an environmentally friendly and

natural gas, but it is explosive. In the event of a leak due to damage of the cooler elements, move your fridge away from open flames or heat sources and ventilate the room where the appliance is located for a few minutes.

- While carrying and positioning the fridge, do not damage the cooler gas circuit.
- Do not store explosive substances such as aerosol cans with a flammable propellant in this appliance.
- This appliance is intended to be used in household and domestic applications such as:
 - staff kitchen areas in shops, offices and other working environments.
 - farm houses and by clients in hotels, motels and other residential type environments.
 - bed and breakfast type environments;
 - catering and similar non-retail applications.
- If the socket does not match the refrigerator plug, it must be replaced by the manufacturer, a service agent or similarly qualified persons in order to avoid a hazard.
- A specially grounded plug has been connected to the power cable of your refrigerator. This plug should be used with a specially grounded socket of 16 amperes. If there is no such socket in your house, please have one installed by an authorised electrician.

- This appliance can be used by children aged from 8 years and above and persons with reduced physical, sensory or mental capabilities or lack of experience and knowledge if they have been given supervision or instruction concerning use of the appliance in a safe way and understand the hazards involved. Children shall not play with the appliance. Cleaning and user maintenance shall not be made by children without supervision.
- Children aged from 3 to 8 years are allowed to load and unload refrigerating appliances. Children are not expected to perform cleaning or user maintenance of the appliance, very young children (0-3 years old) are not expected to use appliances, young children (3-8 years old) are not expected to use appliances safely unless continuous supervision is given, older children (8-14 years old) and vulnerable people can use appliances safely after they have been given appropriate supervision or instruction concerning use of the appliance. Very vulnerable people are not expected to use appliances safely unless continuous supervision is given.
- If the supply cord is damaged, it must be replaced by the manufacturer, an authorised service agent or similar qualified persons, in order to avoid a hazard.
- This appliance is not intended for use at altitudes exceeding 2000 m.

To avoid contamination of food, please respect the following instructions:

- Opening the door for long periods can cause a significant increase of the temperature in the compartments of the appliance.
- Clean regularly surfaces that can come in contact with food and accessible drainage systems
- Store raw meat and fish in suitable containers in the refrigerator, so that it is not in contact with or drip onto other food.
- Two-star frozen-food compartments are suitable for storing pre-frozen food, storing or making ice cream and making ice cubes.
- One-, two- and three-star compartments are not suitable for the freezing of fresh food.
- If the refrigerating appliance is left empty for long periods, switch off, defrost, clean, dry, and leave the door open to prevent mould developing within the appliance.

1.2 Installation warnings

Before using your fridge freezer for the first time, please pay attention to the following points:

- The operating voltage for your fridge freezer is 220-240 V at 50Hz.
- The plug must be accessible after installation.
- Your fridge freezer may have an odour when it is operated for the first time. This is normal and the odour will fade when your fridge freezer starts to cool.
- Before connecting your fridge freezer, ensure that the information on the data plate (voltage and connected load) matches that of the mains electricity supply. If in doubt, consult a qualified electrician.
- Insert the plug into a socket with an efficient ground connection. If the socket has no ground contact or the plug does not match, we recommend you consult a qualified electrician for assistance.
- The appliance must be connected with a properly installed fused socket. The power supply (AC) and voltage at the operating point must match with the details on the name plate of the appliance (the name plate is located on the inside left of the appliance).
- We do not accept responsibility for any damages that occur due to ungrounded usage.
- Place your fridge freezer where it will not be exposed to direct sunlight.
- Your fridge freezer must never be used outdoors or exposed to rain.
- Your appliance must be at least 50 cm away from stoves, gas ovens and heater cores, and at least 5 cm away from electrical ovens.
- If your fridge freezer is placed next to a deep freezer, there must be at least 2 cm between them to prevent humidity forming on the outer surface.

- Do not cover the body or top of fridge freezer with lace. This will affect the performance of your fridge freezer.
- Clearance of at least 150 mm is required at the top of your appliance. Do not place anything on top of your appliance.
- Do not place heavy items on the appliance.
- Clean the appliance thoroughly before use (see Cleaning and Maintenance).
- Before using your fridge freezer, wipe all parts with a solution of warm water and a teaspoon of sodium bicarbonate. Then, rinse with clean water and dry. Return all parts to the fridge freezer after cleaning.
- Use the adjustable front legs to make sure your appliance is level and stable. You can adjust the legs by turning them in either direction. This must be done before placing food in the appliance.

If your refrigerator includes a fan condenser

- **The bottom cabinet cover is the plastic**

The condenser of your fridge is located at the bottom of the cabinet. As a result, the fittings which control the distance between the refrigerator and the wall behind your fridge are located on the cover of the bottom of the cabinet. You can move your fridge toward the back wall until this point.



- **The bottom cabinet cover is the metal**

The condenser of your fridge is placed at the bottom of cabinet. As a result of that, assemble the spacer by fixing it to holes on the cover bottom panel and turn 90° that's shown below figure for arranging the distance between the

refrigerator and the back wall at where you place the fridge. You can move the fridge towards the back wall until that point.

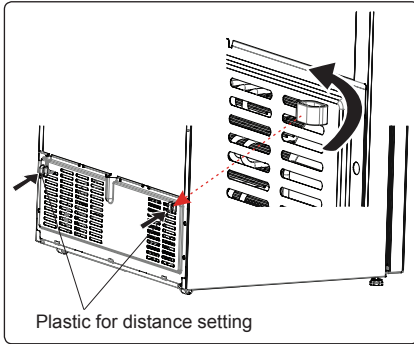

The distance between the appliance and back wall must be a maximum of 75 mm.

1.3 During Usage

- Do not connect your fridge freezer to the mains electricity supply using an extension lead.
- Do not use damaged, torn or old plugs.
- Do not pull, bend or damage the cord.
- Do not use plug adapter.
- This appliance is designed for use by adults. Do not allow children to play with the appliance or hang off the door.
- Never touch the power cord/plug with wet hands. This may cause a short circuit or electric shock.
- Do not place glass bottles or cans in the ice-making compartment as they will burst when the contents freeze.
- Do not place explosive or flammable material in your fridge. Place drinks with high alcohol content vertically in the fridge compartment and make sure their tops are tightly closed.
- When removing ice from the ice-making compartment, do not touch it. Ice may cause frost burns and/or cuts.
- Do not touch frozen goods with wet hands. Do not eat ice-cream or ice cubes immediately after they are removed from the ice-making compartment.

- Do not re-freeze thawed frozen food. This may cause health issues such as food poisoning.

Old and Out-of-order Fridges

- If your old fridge or freezer has a lock, break or remove the lock before discarding it, because children may get trapped inside it and may cause an accident.
- Old fridges and freezers contain isolation material and refrigerant with CFC. Therefore, take care not to harm environment when you are discarding your old fridges.

CE Declaration of conformity

We declare that our products meet the applicable European Directives, Decisions and Regulations and the requirements listed in the standards referenced.

Disposal of your old appliance

The symbol on the product or on its packaging indicates that this product may not be treated as household waste. Instead it shall be handed over to the applicable collection point for the recycling of electrical and electronic equipment. By ensuring this product is disposed of correctly, you will help prevent potential negative consequences for the environment and human health, which could otherwise be caused by inappropriate waste handling of this product. For more detailed information about recycling of this product, please contact your local city office, your household waste disposal service or the shop where you purchased the product.



Packaging and the Environment

Packaging materials protect your machine from damage that may occur during transportation. The packaging materials are environmentally friendly as they are recyclable. The use of recycled material reduces raw material consumption and therefore decreases waste production.



Notes:

- Please read the instruction manual carefully before installing and using your appliance. We are not responsible for the damage occurred due to misuse.
- Follow all instructions on your appliance and instruction manual, and keep this manual in a safe place to resolve the problems that may occur in the future.
- This appliance is produced to be used in homes and it can only be used in domestic environments and for the specified purposes. It is not suitable for commercial or common use. Such use will cause the guarantee of the appliance to be cancelled and our company will not be responsible for any losses incurred.
- This appliance is produced to be used in houses and it is only suitable for cooling / storing foods. It is not suitable for commercial or common use and/or for storing substances except for food. Our company is not responsible for any losses incurred by inappropriate usage of the appliance.

General notes:

Fresh Food Compartment (Fridge): Most efficient use of energy is ensured in the configuration with the drawers in the bottom part of the appliance, and shelves evenly distributed, position of door bins does not affect energy consumption.

Freezer Compartment (Freezer): Most Efficient use of energy is ensured in the configuration with the drawers and bins are on stock position.

2 DESCRIPTION OF THE APPLIANCE

This appliance is not intended to be used as a built-in appliance.

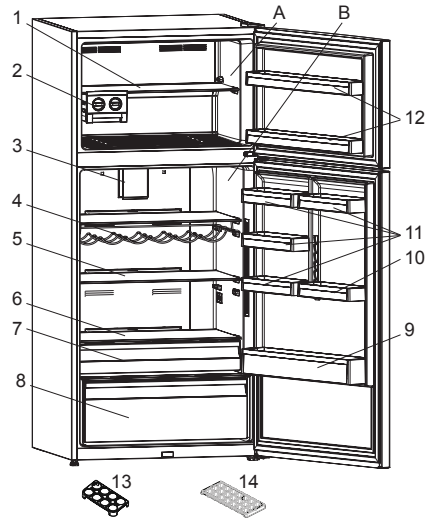

 This presentation is only for information about the parts of the appliance. Parts may vary according to the appliance model.

A) Freezer compartment

B) Refrigerator compartment

- 1) Freezer shelf
- 2) Icemaker *
- 3) Turbo fan *
- 4) Wine rack *
- 5) Refrigerator shelves
- 6) Chiller *
- 7) Crisper cover
- 8) Crisper
- 9) Bottle shelf
- 10) Adjustable door shelf * / door shelf
- 11) Door shelves
- 12) Freezer door shelves *
- 13) Egg holder
- 14) Ice box tray *

* In some models

2.1 Dimensions

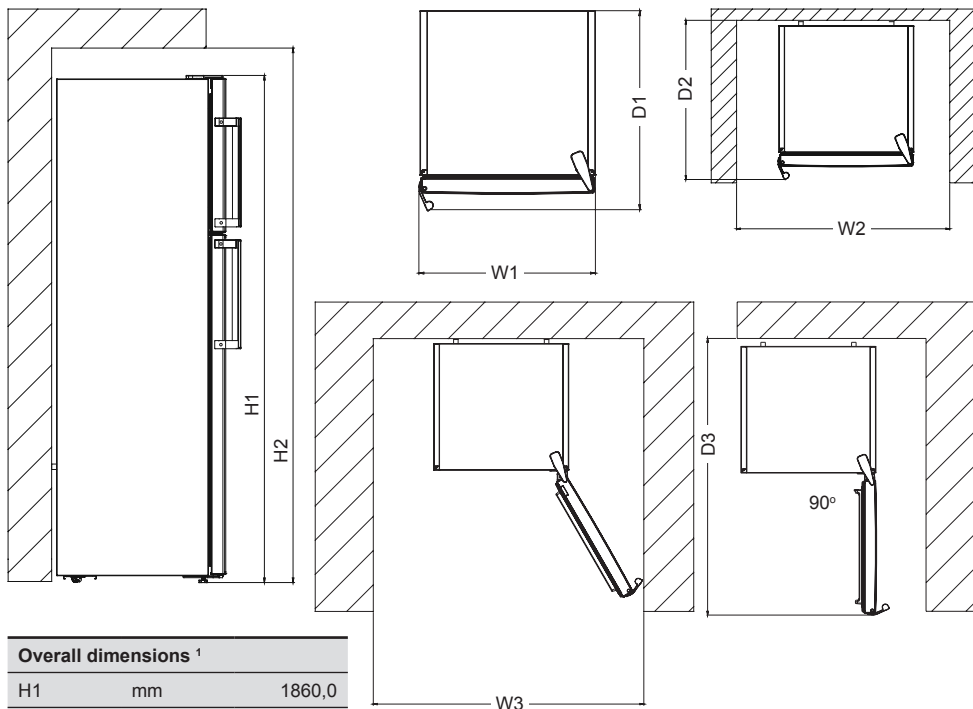

Overall dimensions ¹		
H1	mm	1860,0
W1	mm	840,0
D1	mm	750,0

¹ the height, width and depth of the appliance without the handle.

Space required in use ²		
H2	mm	2010,0
W2	mm	940,0
D2	mm	815,7

² the height, width and depth of the appliance including the handle, plus the space necessary for free circulation of the cooling air.

Overall space required in use ³		
W3	mm	1535,2
D3	mm	1547,5

³ the height, width and depth of the appliance including the handle, plus the space necessary for free circulation of the cooling air, plus the space necessary to allow door opening to the minimum angle permitting removal of all internal equipment.

3 USING THE APPLIANCE

3.1 Information about New Generation Cooling Technology

Fridges with new-generation cooling technology have a different operating system to static fridges. Other (static) fridges may experience a build up of ice in the freezer compartment due to door openings and humidity in the food. In such fridges, regular defrosting is required; the fridge must be switched off, the frozen food moved to a suitable container and the ice which has formed in the freezer compartment removed.

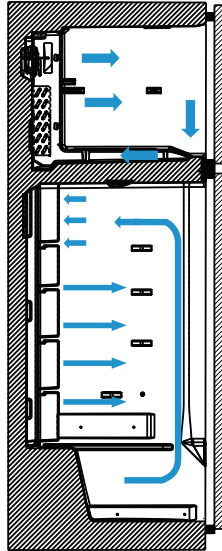

In fridges with new-generation cooling technology, a fan blows dry cold air evenly throughout the fridge and freezer compartments. The cold air cools your food evenly and uniformly, preventing humidity and ice build-up.

In the refrigerator compartment, air blown by the fan, located at the top of the refrigerator compartment, is cooled while passing through the gap behind the air duct. At the same time, the air is blown out through the holes in the air duct, evenly spreading cool air throughout the refrigerator compartment.

There is no air passage between the freezer and refrigerator compartments, therefore preventing the mixing of odours.

As a result, your fridge, with new-generation cooling technology, provides you with ease of use as well as a huge volume and aesthetic appearance.

3.2 Display and Control Panel

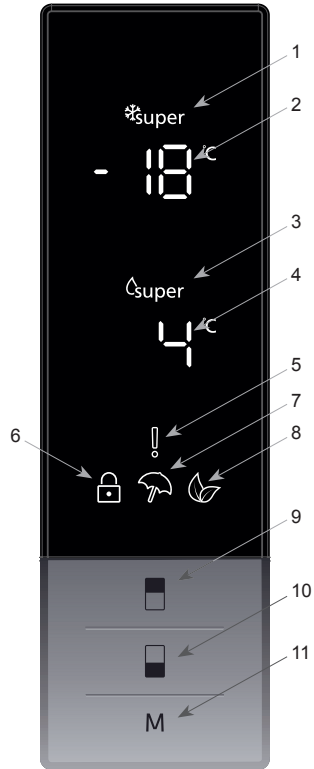

Using the Control Panel

1. It is super freeze indicator.
2. It is freezer set value screen.
3. It is super cooling indicator.
4. It is cooler set value screen.
5. It is alarm symbol.
6. It is child-lock symbol.
7. It is holiday mode symbol.
8. It is economy mode symbol.
9. It enables the setting value of freezer to be modified and super freeze mode to be activated if desired. Freezer may be set to -16, -18, -20, -22, -24 °C super freeze.
10. It enables the setting value of cooler to be modified and super cool mode to be activated if desired. Cooler maybe set to 8, 6, 5, 4, 2 °C super cool.
11. It enables the modes (economy, holiday...) to be activated if desired.

3.3 Operating Your Fridge Freezer

Lighting (If available)

When the product is plugged in for the first time, the interior lights may turn on 1 minute late due to opening tests.

3.3.1 Super Freeze Mode

Purpose

- To freeze a large quantity of food that cannot fit on the fast freeze shelf.
- To freeze prepared foods.
- To freeze fresh food quickly to retain freshness.

How Would It Be Used?

Press freezer set button until Super freeze symbol will be seen on the screen. Buzzer will sound beep beep. Mode will be set.

During This Mode:

- Temperature of cooler and super cool mode may be adjusted. In this case super freeze mode continues.
- Economy and Holiday mode can not be selected.
- Super freeze mode can be cancelled by the same operation of selecting.

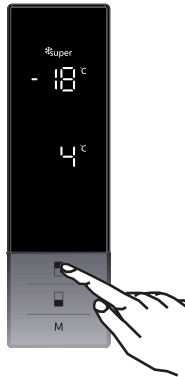

Notes:

- The maximum amount of fresh food (in kilograms) that can be frozen within 24 hours is shown on the appliance label.
- For optimal appliance performance in maximum freezer capacity, activate SF mode 3 hours before you put fresh food into the freezer.
- At the end of this period, the fridge will sound an audible alarm notifying that it is ready.

 Super freeze mode will automatically cancel after 24 hours, depending on the environmental temperature or when the freezer sensor reaches a sufficiently low temperature.

3.3.2 Super Cool Mode

Purpose

- To cool and store a large quantity of food in the fridge compartment.
- To quickly cool drinks.

How Would It Be Used?

Press cooler set button until super cool symbol will be seen on the screen. Buzzer will sound beep beep. Mode will be set.

During This Mode:

- Temperature of freezer and super freeze mode may be adjusted. In this case super cool mode continues.
- Economy and holiday mode can not be selected.
- Super cool mode can be cancelled by the same operation of selecting.



3.3.3 Economy Mode

Purpose

Energy savings. During periods of less frequent use (door opening) or absence from home, such as a holiday, Eco program can provide optimum temperature whilst saving power.

How Would It Be Used?

- Push "MODE" button until eco symbol appears.
- If no button is pressed for 1 second. Mode will be set. Eco symbol will blink 3 times. When mode is set, buzzer will sound beep beep.
- Freezer and refrigerator temperature segments will show "E".
- Economy symbol and E will light till mode finishes.



During This Mode:

- Freezer may be adjusted. When economy mode will be cancelled, the selected setting values will proceed.
- Cooler may be adjusted. When economy mode will be cancelled, the selected setting values will proceed.
- Super cool and super freeze modes can be selected. Economy mode is automatically cancelled and the selected mode is activated.
- Holiday mode can be selected after cancelling the economy mode. Then the selected mode is activated.
- To cancel, you will just need to press on mode button.

3.3.4 Holiday Mode

How Would It Be Used?

- Push "MODE" button until holiday symbol appears
- If no button is pressed for 1 second. Mode will be set. Holiday symbol will blink 3 times. When mode is set, buzzer will sound beep beep.
- Cooler temperature segment will show "--".
- Holiday symbol and "--" will light till mode finishes.



During This Mode:

- Freezer may be adjusted. When holiday mode will be cancelled, the selected setting values will proceed.
- Cooler may be adjusted. When holiday mode will be cancelled, the selected setting values will proceed.
- Super cool and super freeze modes can be selected. Holiday mode is automatically cancelled and the selected mode is activated.
- Economy mode can be selected after cancelling the holiday mode. Then the selected mode is activated.
- To cancel, you will just need to press on mode button.

3.3.5 Drink Cool Mode

Purpose

This mode is used to cool drinks within an adjustable time frame.

How Would It Be Used?

- Press freezer button for 3 seconds.
- Special animation will start on freezer set value screen and 05 will blink on cooler set value screen.
- Press cooler button to adjust the time (05 - 10 - 15 - 20 - 25 - 30 minutes).
- When you select the time the numbers will blink 3 times on screen and sound beep beep.
- If no button is pressed within 2 seconds the time will be set.
- The countdown starts from the adjusted time minute by minute.
- Remaining time will blink on the screen.
- To cancel this mode press freezer set button for 3 seconds.

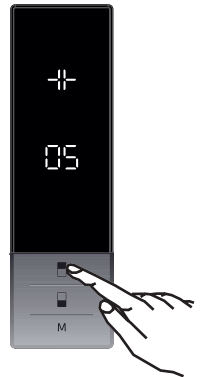

3.3.6 Screen Saver Mode

Purpose

This mode saves energy by switching off all control panel lighting when the panel is left inactive.

How to Use?

- Screen saver mode will be activated automatically after 30 seconds.
- If you press any key while the lighting of the control panel is off, the current machine settings will reappear on the display to let you make any change you wish.
- If you do not cancel the screen saving mode or press any key for 30

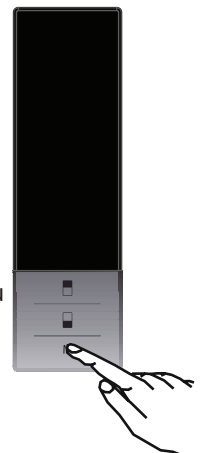

seconds, control panel will remain off.

To deactivate the screen saving mode,

- To cancel the screen saving mode, first of all, you need to press any key to activate the keys and then press and hold the Mode button for 3 seconds.
- To reactivate screen saving mode, press and hold the mode button for 3 seconds.

Notes:

- When screen saver mode is active you can also activate child lock.
- If no button is pressed within 5 seconds after child lock is activated, the lights of the control panel will turn off. You can see latest status of settings or modes after you press any button. While control panel's light is on, you can cancel child lock as described in the instruction of this mode.

3.3.7 The Child Lock Function

Purpose

Child lock can be activated to prevent any accidental or unintentional changes being made to the appliance settings.

Activating Child Lock

Press on freezer and cooler buttons simultaneously for 5 seconds.

Deactivating Child Lock

Press on freezer and cooler buttons simultaneously for 5 seconds.



Child lock will also be deactivated if electricity is interrupted or the fridge is unplugged.

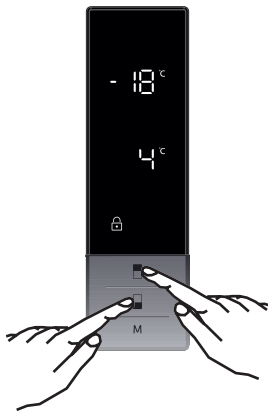

3.4 Temperature Settings

3.4.1 Freezer Temperature Settings

- The initial temperature value for the freezer setting indicator is -18°C .
- Press the set freezer button once.
- When you first push this button, the last set value will blink on the screen.
- Whenever you press this button, a lower temperature will be set (-16°C , -18°C , -20°C , -22°C , -24°C , super freeze).
- When you push the set freezer button until the super freeze symbol appears, and if you do not push any other button within 1 second, super freeze will flash.
- If you continue to press it, it will restart from -16°C .
- The temperature value selected before holiday mode, super freeze mode, super cool mode or economy mode is activated and will remain the same when the mode is over or cancelled. The appliance continues to operate with this temperature value.

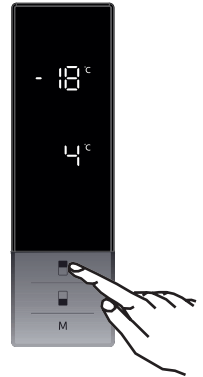

3.4.2 Cooler Temperature Settings

- Initial temperature value for the cooler setting indicator is +4 °C.
- Press the cooler button once.
- When you first push this button, the last value will appear on the cooler setting indicator.
- Whenever you press this button, a lower temperature will be set. (+8 °C, +6 °C, +5 °C, +4 °C, +2 °C, super cool)
- When you push the cooler set button until the super cool symbol appears, and if you do not push any button within 1 second, super cool will flash.
- If you continue to press the button, it will restart from +8 °C.
- The temperature value selected before holiday mode, super freeze mode, super cool mode or economy mode is activated and will remain the same when the mode is over or cancelled. The appliance continues to operate with this temperature value.



Recommended Settings for the Freezer and Cooler Compartment Temperature

Freezer Compartment	Cooler Compartment	Remarks
-18 °C	4 °C	For regular use and best performance.
-20 °C, -22 °C or -24 °C	4 °C	Recommended when environmental temperature exceeds 30 °C.
Super Freeze	4 °C	Must be used when you wish to freeze food in a short period of time.

Freezer Compartment	Cooler Compartment	Remarks
-18 °C, -20 °C, -22 °C or -24 °C	2 °C	These temperature settings must be used when the environmental temperature is high or if you think the refrigerator compartment is not cool enough because the door is being opened frequently.
-18 °C, -20 °C, -22 °C or -24 °C	Super Cool	Must be used when the refrigerator compartment is overloaded with food or when food needs to be cooled quickly.

3.4.3 Door Open Alarm Function

If fridge door is opened more than 2 minutes, appliance sounds 'beep beep'.

3.5 Temperature Adjustment Warnings

- It is not recommended that you operate your fridge in environments colder than 10°C in terms of its efficiency.
- Do not start another adjustment while you are already making an adjustment.
- Temperature adjustments should be made according to the frequency of door openings, the quantity of food kept inside the fridge and the ambient temperature in the location of your fridge.
- In order to allow your fridge to reach the operating temperature after being connected to mains, do not open the doors frequently or place large quantities of food in the fridge. Please note that, depending on the ambient temperature, it may take 24 hours for your fridge to reach the operating temperature.
- A 5 minute delay function is applied to prevent damage to the compressor of your fridge when connecting or disconnecting to mains, or when an energy breakdown occurs. Your fridge will begin to operate normally after 5 minutes.

- Your appliance is designed to operate in the ambient temperature (T/SN = 10°C - 43°C) intervals stated in the standards, according to the climate class displayed on the information label. We do not recommend operating your appliance out of the stated temperature limits in terms of cooling effectiveness.

Climate class and meaning:

T (tropical): This refrigerating appliance is intended to be used at ambient temperatures ranging from 16 °C to 43 °C.

ST (subtropical): This refrigerating appliance is intended to be used at ambient temperatures ranging from 16 °C to 38 °C.

N (temperate): This refrigerating appliance is intended to be used at ambient temperatures ranging from 16 °C to 32 °C.

SN (extended temperate): This refrigerating appliance is intended to be used at ambient temperatures ranging from 10 °C to 32 °C.

3.6 Accessories

Visual and text descriptions in the accessories section may vary according to the model of your appliance.

3.6.1 The Icematic

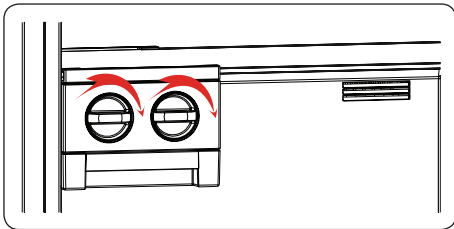

- Pull the lever towards you and remove the ice maker tray
- Fill with water to the marked level
- Hold the left end of the lever and set the ice-tray on the icebox
- When ice cubes have formed, twist the lever to drop the ice cubes into the icebox.

Note:

- Do not fill the icebox with water in order to make ice. It can be broken.

- The movement of the ice maker may be difficult while the refrigerator is running. In such a case should be cleaned by removing the glass shelves.

Removing the icemaker

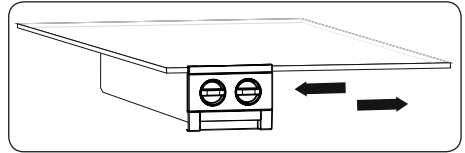

- Take out of the freezer glass shelves
- Remove the icemaker by dragging left or right on the shelf.

You can remove the icemaker to use a larger volume of the freezer compartment.

3.6.2 The Chiller Shelf

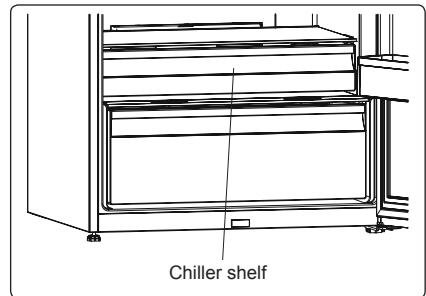

Keeping food in the Chiller compartment, instead of the freezer or refrigerator compartments, allows food to retain freshness and flavour for longer, while preserving its fresh appearance. When the Chiller tray becomes dirty, remove it and wash with water.

(Water freezes at 0°C, but food containing salt or sugar freezes at temperatures lower than this).

The Chiller compartment is usually used for storing foods such as raw fish, lightly pickled food, rice, and so on.

⚠ Do not put food you want to freeze or ice trays (to make ice) in the Chiller compartment.

To remove the Chiller Shelf:

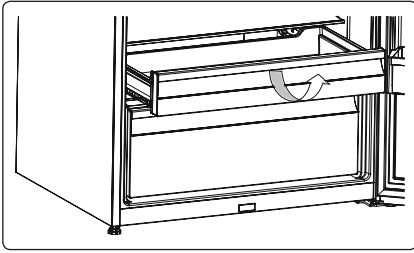

- Pull the chiller shelf towards you by sliding it on the rails.
- Pull the chiller shelf up from the rail and remove it from the fridge.

 After the chiller shelf is removed, there will be space for up to 20kg of food to be placed in the fridge.

3.6.3 The Fresh Dial

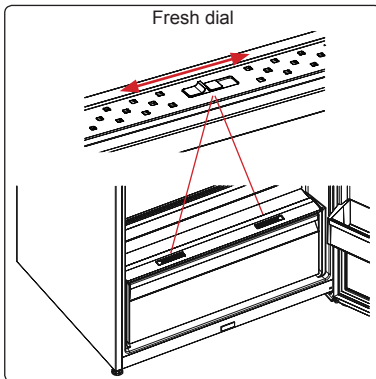

If the crisper is full, the fresh dial located in front of the crisper should be opened. This allows the air in the crisper and the humidity rate to be controlled, to increase the life of food within.

The dial, located behind the shelf, must be opened if any condensation is seen on the glass shelf.

3.6.4 Adjustable Door Shelf

Five different height adjustments can be made to provide storage areas that you need by adjustable door shelf.

To change the position of adjustable door shelf; Lift up front of the shelf (1) and move up or down adjustable door shelf (2) with both hands (Pict. 1)

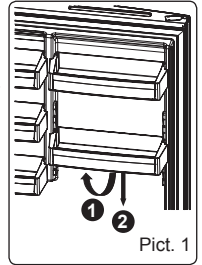

Before releasing the door shelf make sure the door shelf is located at door positions.

4 FOOD STORAGE

4.1 Refrigerator Compartment



For normal operating conditions, set the temperature of the cooler compartment to +4 or +6 °C.

- To reduce humidity and avoid the consequent formation of frost, always store liquids in sealed containers in the refrigerator. Frost tends to concentrate in the coldest parts of the evaporating liquid and, in time, your appliance will require more frequent defrosting.
- Never place warm food in the refrigerator. Warm food should be allowed to cool at room temperature and should be arranged to ensure adequate air circulation in the refrigerator compartment.
- Make sure no items are in direct contact with the rear wall of the appliance as frost will develop and packaging will stick to it. Do not open the refrigerator door frequently.
- We recommend that meat and clean fish are loosely wrapped and stored on the glass shelf just above the vegetable bin where the air is cooler, as this provides the best storage conditions.
- Store loose fruit and vegetable items in the crisper containers.
- Store loose fruit and vegetables in the crisper.
- Storing fruit and vegetables separately helps prevent ethylene-sensitive vegetables (green leaves, broccoli, carrot, etc.) being affected by ethylene-releaser fruits (banana, peach, apricot, fig etc.).
- Do not put wet vegetables into the refrigerator.
- Storage time for all food products depends on the initial quality of the food and an uninterrupted refrigeration cycle before refrigerator storage.
- To avoid cross-contamination do not store meat products with fruit and

vegetables. Water leaking from meat may contaminate other products in the refrigerator. You should package meat products and clean any leakages on the shelves.

- Do not put food in front of the air flow passage.
 - Consume packaged foods before the recommended expiry date.
-  **NOTE:** Potatoes, onions and garlic should not be stored in the refrigerator.
- For normal working conditions, it will be sufficient to adjust the temperature setting of your refrigerator to +4 °C.
 - The temperature of the fridge compartment should be in the range of 0-8 °C, fresh foods below 0 °C are iced and rotted, bacterial load increases above 8 °C, and spoils.
 - Do not put hot food in the refrigerator immediately, wait for the temperature to pass outside. Hot foods increase the degree of your refrigerator and cause food poisoning and unnecessary spoiling of the food.
 - Meat, fish, etc. should be store in the chiller compartment of the food, and the vegetable compartment is preferred for vegetables. (if available)
 - To prevent cross contamination, meat products and fruit vegetables are not stored together.
 - Foods should be placed in the refrigerator in closed containers or covered to prevent moisture and odors.

IMPORTANT NOTES:

-  Potatoes, onions and garlic should not be stored in the refrigerator.
-  Cooked dishes must remain covered when they are kept in the fridge. Place them in the fridge when they are cool, otherwise the temperature/humidity inside the fridge will increases, reducing the fridge's efficiency. Covering food and drink also preserves their flavour and aroma.



Do not allow food to come into contact with the temperature sensor, which is located in the refrigerator compartment, in order to keep the refrigerator compartment at optimum temperature.

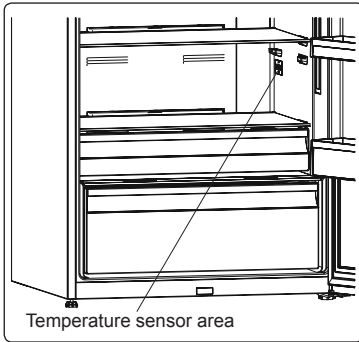

The table below is a quick guide to show you the most efficient way to store the major food groups in your refrigerator compartment.

Food	Maximum storage time	How and where to store
Vegetables and fruits	1 week	Vegetable bin
Meat and fish	2 - 3 days	Wrap in plastic foil, bags, or in a meat container and store on the glass shelf
Fresh cheese	3 - 4 days	On the designated door shelf
Butter and margarine	1 week	On the designated door shelf
Bottled products e.g. milk and yoghurt	Until the expiry date recommended by the producer	On the designated door shelf
Eggs	1 month	On the designated egg shelf
Cooked food	2 days	All shelves

4.2 Freezer Compartment

For normal operating conditions, set the temperature of the freezer compartment to -18 or -20 °C.

- The freezer is used for storing frozen food, freezing fresh food, and making ice cubes.
- For freezing fresh food; wrap and seal

fresh food properly, that is the packaging should be air tight and shouldn't leak. Special freezer bags, aluminum foil polythene bags and plastic containers are ideal.

- Do not store fresh food next to frozen food as it can thaw the frozen food.
- Before freezing fresh food, divide it into portions that can be consumed in one sitting.
- Consume thawed frozen food within a short period of time after defrosting
- Never place warm food in the freezer compartment as it will thaw the frozen food.
- Always follow the manufacturer's instructions on food packaging when storing frozen food. If no information is provided food, should not be stored for more than 3 months from the date of purchase.
- When purchasing frozen food, make sure that it has been stored under appropriate conditions and that the packaging is not damaged.
- Frozen food should be transported in appropriate containers and placed in the freezer as soon as possible.
- Do not purchase frozen food if the packaging shows signs of humidity and abnormal swelling. It is probable that it has been stored at an unsuitable temperature and that the contents have deteriorated.
- The storage life of frozen food depends on the room temperature, the thermostat setting, how often the door is opened, the type of food, and the length of time required to transport the product from the shop to your home. Always follow the instructions printed on the packaging and never exceed the maximum storage life indicated.
- The maximum amount of fresh food (in kg) that can be frozen in 24 hours is indicated on the appliance label.
- To freeze fresh food, ensure that as much

of the surface of the food as possible is in contact with the cooling surface.

In some models: While loading the freezer compartment, do not fill above the guidelines otherwise the door will not close properly. If the freezer compartment door does not close properly, excess ice will form in the freezer compartment. To

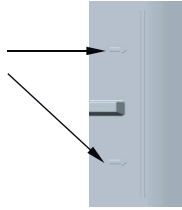

prevent the problem recurring, clear the ice and make sure the door is fully closed.

Also, not closing the freezer and/or fridge compartment doors will increase your energy consumption.

If the lower shelf of the freezer door is removed and food obstructs the air suction hole, the efficiency of your fridge will reduce.

Therefore, take care while loading the freezer compartment and make sure not to cover the air suction hole.

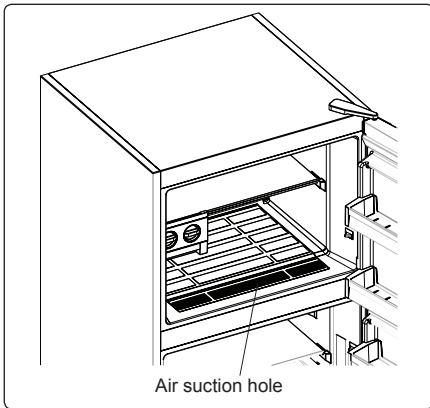

NOTE: If you attempt to open the freezer door immediately after closing it, you will find that it will not open easily. This is normal. Once equilibrium has been reached, the door will open easily.

Important note:

- Never refreeze thawed frozen food.
- The taste of some spices found in cooked dishes (anise, basilica, watercress, vinegar, assorted spices, ginger, garlic, onion, mustard, thyme, marjoram, black pepper, etc.) changes and they assume a strong taste when they are stored for a long period of time. Therefore, add small amounts of spices to food to be frozen, or the desired spice should be added after the food has thawed.
- The storage time of food is dependent on the type of oil used. Suitable oils are margarine, calf fat, olive oil and butter. Unsuitable oils are peanut oil and pig fat.
- Food in liquid form should be frozen in plastic cups and other food should be frozen in plastic folios or bags.



The table below is a quick guide to

show you the most efficient way to store the major food groups in your freezer compartment.

Meat and fish	Preparation	Maximum storage time (months)
Steak	Wrap in foil	6 - 8
Lamb meat	Wrap in foil	6 - 8
Veal roast	Wrap in foil	6 - 8
Veal cubes	In small pieces	6 - 8
Lamb cubes	In pieces	4 - 8
Minced meat	In packaging without using spices	1 - 3
Giblets (pieces)	In pieces	1 - 3
Bologna sausage/salami	Should be kept packaged even if it has a membrane	
Chicken and turkey	Wrap in foil	4 - 6
Goose and duck	Wrap in foil	4 - 6
Deer, rabbit, wild boar	In 2.5 kg portions or as fillets	6 - 8
Freshwater fish (Salmon, Carp, Crane, Catfish)	After cleaning the bowels and scales of the fish, wash and dry it. If necessary, remove the tail and head.	2
Lean fish (Bass, Turbot, Flounder)		4
Fatty fishes (Tuna, Mackerel, Bluefish, Anchovy)		2 - 4
Shellfish	Clean and in a bag	4 - 6
Caviar	In its packaging, or in an aluminium or plastic container	2 - 3
Snails	In salty water, or in an aluminium or plastic container	3
 NOTE: Thawed frozen meat should be cooked as fresh meat. If the meat is not cooked after defrosting, it must not be re-frozen.		



Vegetables and Fruits	Preparation	Maximum storage time (months)
String beans and beans	Wash, cut into small pieces and boil in water	10 - 13
Beans	Hull, wash and boil in water	12
Cabbage	Clean and boil in water	6 - 8
Carrot	Clean, cut into slices and boil in water	12
Pepper	Cut the stem, cut into two pieces, remove the core and boil in water	8 - 10
Spinach	Wash and boil in water	6 - 9
Cauliflower	Remove the leaves, cut the heart into pieces and leave it in water with a little lemon juice for a while	10 - 12
Eggplant	Cut into pieces of 2cm after washing	10 - 12
Corn	Clean and pack with its stem or as sweet corn	12
Apple and pear	Peel and slice	8 - 10
Apricot and Peach	Cut into two pieces and remove the stone	4 - 6

Vegetables and Fruits	Preparation	Maximum storage time (months)
Strawberry and Blackberry	Wash and hull	8 - 12
Cooked fruits	Add 10 % of sugar to the container	12
Plum, cherry, sourberry	Wash and hull the stems	8 - 12

	Maximum storage time (months)	Thawing time at room temperature (hours)	Thawing time in oven (minutes)
Bread	4 - 6	2 - 3	4-5 (220-225 °C)
Biscuits	3 - 6	1 - 1,5	5-8 (190-200 °C)
Pastry	1 - 3	2 - 3	5-10 (200-225 °C)
Pie	1 - 1,5	3 - 4	5-8 (190-200 °C)
Phyllo dough	2 - 3	1 - 1,5	5-8 (190-200 °C)
Pizza	2 - 3	2 - 4	15-20 (200 °C)

Dairy products	Preparation	Maximum storage time (months)	Storage conditions
Packet (Homogenized) Milk	In its own packet	2 - 3	Pure Milk – in its own packet
Cheese - excluding white cheese	In slices	6 - 8	Original packaging may be used for short-term storage. Keep wrapped in foil for longer periods.
Butter, margarine	In its packaging	6	

5 CLEANING AND MAINTENANCE

-  Disconnect the unit from the power supply before cleaning.
-  Do not wash your appliance by pouring water on it.
-  Do not use abrasive products, detergents or soaps for cleaning the appliance. After washing, rinse with clean water and dry carefully. When you have finished cleaning, reconnect the plug to the mains supply with dry hands.
- Make sure that no water enters the lamp housing and other electrical components.
- The appliance should be cleaned regularly using a solution of bicarbonate of soda and lukewarm water.
- Clean the accessories separately by hand with soap and water. Do not wash accessories in a dish washer.

- Clean the condenser with a brush at least twice a year. This will help you to save on energy costs and increase productivity.

  **The power supply must be disconnected during cleaning.**

Replacing LED Lighting

 If your appliance has LED lighting contact the help desk as this should be changed by authorized personnel only.

6 SHIPMENT AND REPOSITIONING

6.1 Transportation and Changing Positioning

- The original packaging and foam may be kept for re-transportation (optional).
- Fasten your appliance with thick packaging, bands or strong cords and follow the instructions for transportation on the packaging.
- Remove all movable parts (shelves, accessories, vegetable bins, and so on) or fix them into the appliance against shocks using bands when re-positioning or transporting.



Always carry your appliance in the upright position.

6.2 Repositioning the Door

- It is not possible to change the opening direction of your appliance door if door handles are installed on the front surface of the appliance door.
- It is possible to change the opening direction of the door on models without handles.
- If the door-opening direction of your appliance can be changed, contact the nearest Authorised Service Centre to change the opening direction.

7 BEFORE CALLING AFTER-SALES SERVICE

Errors

Your fridge will warn you if the temperatures for the cooler and freezer are at improper levels or if a problem occurs with the appliance. Warning codes are displayed in the freezer and cooler indicators.

ERROR TYPE	MEANING	WHY	WHAT TO DO
E01	Sensor warning		Call Service for assistance as soon as possible.
E02	Sensor warning		Call Service for assistance as soon as possible.
E03	Sensor warning		Call Service for assistance as soon as possible.
E06	Sensor warning		Call Service for assistance as soon as possible.
E07	Sensor warning		Call Service for assistance as soon as possible.
E08	Low Voltage Warning	Power supply to the device has dropped to below 170 V.	<ul style="list-style-type: none"> - This is not a device failure, this error helps to prevent damages to the compressor. - The voltage needs to be increased back to required levels <p>If this warning continues an authorised technician needs to be contacted.</p>
E09	Freezer compartment is not cold enough	Likely to occur after long term power failure.	<ol style="list-style-type: none"> 1. Set the freezer temperature to a colder value or set Super Freeze. This should remove the error code once the required temperature has been reached. Keep doors closed to improve time taken to reach the correct temperature. 2. Remove any products which have thawed/defrosted during this error. They can be used within a short period of time. 3. Do not add any fresh produce to the freezer compartment until the correct temperature has been reached and the error is no longer. <p>If this warning continues an authorised technician needs to be contacted.</p>

ERROR TYPE	MEANING	WHY	WHAT TO DO
E10	Fridge compartment is not cold enough	Likely to occur after: - Long term power failure. - Hot food has been left in the fridge.	1. Set the fridge temperature to a colder value or set Super Cool. This should remove the error code once the required temperature has been reached. Keep doors closed to improve time taken to reach the correct temperature. 2. Please empty the location at the front area of air duct channel holes and avoid putting food close to the sensor. If this warning continues an authorised technician needs to be contacted.
E11	Fridge compartment is too cold	Various	1. Check is Super Cool mode is activated 2. Reduce the fridge compartment temperature 3. Check to see if vents are clear and not clogged If this warning continues an authorised technician needs to be contacted.

If you are experiencing a problem with your refrigerator, please check the following before contacting the after-sales service.

Your refrigerator does not operate

Check if:

- Your fridge is plugged in and switched on
- The fuse has blown
- Is the temperature adjustment right?
- The socket is faulty. To check this, plug another working appliance into the same socket.

Your refrigerator is performing poorly

Check if:

- The appliance is overloaded
- The doors are closed properly
- There is any dust on the condenser
- There is an adequate distance between the appliance and surrounding walls

Your refrigerator is operating noisily

The following noises can be heard during normal operation of the appliance.

Cracking (ice cracking) noise occurs:

- During automatic defrosting.
- When the appliance is cooled or warmed (due to expansion of appliance material).

Clicking noise occurs: When the thermostat switches the compressor on/off.

Motor noise: Indicates the compressor is operating normally. The compressor may cause more noise for a short time when it is first activated.

Bubbling noise and splashing occurs: Due to the flow of the refrigerant in the tubes of the system.

Water flowing noise occurs: Due to water flowing to the evaporation container. This noise is normal during defrosting.

Air blowing noise occurs: During normal operation of the system due to the circulation of air.

There is a build-up of humidity inside the fridge

Check if:

- All food is packed properly. Containers must be dry before being placed in the fridge.
- The fridge doors are opened frequently. Humidity of the room will enter the fridge each time the doors are opened.

Humidity increases faster if the doors are opened frequently, especially if the humidity of the room is high.

- There is a build-up of water droplets on the rear wall. This is normal after automatic defrosting (in Static Models).

The doors are not opening or closing properly

Check if:

- There is food or packaging preventing the door from closing
- The door compartments, shelves and drawers are placed properly
- The door gaskets are broken or torn
- Your fridge is level.

The edges of the fridge in contact with the door joint are warm

Especially during summer (warm weather), the surfaces in contact with the door joint may become warmer during operation of the compressor. This is normal.

Important Notes:

- In the case of a power failure, or if the appliance is unplugged and plugged in again, the gas in the cooling system of your refrigerator will destabilise, causing the compressor protective thermal element to open. Your refrigerator will start to operate normally after 5 minutes.
- If the appliance will not be used for a long period of time (such as during holidays), disconnect the plug. Defrost and clean the refrigerator, leaving the door open to prevent the formation of mildew and odour.
- If the problem persists after you have followed all the instructions above, please consult the nearest Authorised Service Centre.
- This appliance is designed for domestic use and for the stated purposes only. It is not suitable for commercial or common use. If the consumer uses the appliance in a way that does not comply with these instructions, we emphasise that the manufacturer and the dealer will not be responsible for any repair or failure within the guarantee period.

8 TIPS FOR SAVING ENERGY

1. Install the appliance in a cool, well-ventilated room, but not in direct sunlight and not near a heat source (such as a radiator or oven) otherwise an insulating plate should be used.
2. Allow warm food and drinks to cool before placing them inside the appliance.
3. Place thawing food in the refrigerator compartment. The low temperature of the frozen food will help cool the refrigerator compartment while the food is thawing. This will save energy. Frozen food left to thaw outside of the appliance will result in a waste of energy.
4. Drinks or other liquids should be covered when inside the appliance. If left uncovered, the humidity inside the appliance will increase, therefore the appliance uses more energy. Keeping drinks and other liquids covered helps preserve their smell and taste.
5. Avoid keeping the doors open for long periods and opening the doors too frequently as warm air will enter the appliance and cause the compressor to switch on unnecessarily often.
6. Keep the covers of the different temperature compartments (such as the crisper and chiller) closed.
7. The door gasket must be clean and pliable. In case of wear, replace the gasket.

9 TECHNICAL DATA

The technical information is situated in the rating plate on the internal side of the appliance and on the energy label.

The QR code on the energy label supplied with the appliance provides a web link to the information related to the performance of the appliance in the EU EPREL database.

Keep the energy label for reference together with the user manual and all other documents provided with this appliance.

It is also possible to find the same information in EPREL using the link <https://eprel.ec.europa.eu> and the model name and product number that you find on the rating plate of the appliance.

See the link www.theenergylabel.eu for detailed information about the energy label.

10 INFORMATION FOR TEST INSTITUTES

Appliance for any EcoDesign verification shall be compliant with EN 62552.

Ventilation requirements, recess dimensions and minimum rear clearances shall be as stated in this User Manual at Chapter 2. Please contact the manufacturer for any other further information, including loading plans.

11 CUSTOMER CARE AND SERVICE

Always use original spare parts.

When contacting our Authorised Service Centre, ensure that you have the following data available: Model, Serial Number and Service Index.

The information can be found on the rating plate. You can find the rating label inside the fridge zone on the left lower side.

The original spare parts for some specific components are available for a minimum of 7 or 10 years, based on the type of component, from the placing on the market of the last unit of the model.

Visit our website to:

Get User manuals: <https://www.smeg.com/info/download-manuals>

Get Service information: <https://www.smeg.com/services/customer-service>