

# C6IMXT2

Cooker size	60x60 cm
N. of cavities with energy label	1
Cavity heat source	ELECTRICITY
Hob type	Induction
Type of main oven	Fan assisted
Cleaning system main oven	Vapor Clean
EAN code	8017709329013
Energy efficiency class	A



## Aesthetics



<b>Aesthetic</b>	Classica	<b>Type of control knobs</b>	Smeg Classic
<b>Series</b>	Concerto	<b>Controls colour</b>	Stainless steel
<b>Design</b>	Standard	<b>No. of controls</b>	2
<b>Colour</b>	Stainless steel	<b>Serigraphy colour</b>	Black
<b>Finishing</b>	Satin	<b>Display name</b>	DigiScreen
<b>Command panel finish</b>	Stainless steel	<b>Door</b>	Full glass
<b>Logo</b>	Embossed	<b>Glass type</b>	Eclipse
<b>Logo position</b>	Facia below the oven	<b>Handle</b>	Smeg Classic
<b>Hob colour</b>	Stainless steel	<b>Handle Colour</b>	Brushed stainless steel
<b>Type of control setting hob</b>	Digi Touch	<b>Feet color</b>	Black
<b>Hob LED colours</b>	Red		

## Programs / Functions main oven

No. of cooking functions 6

Traditional cooking functions



Static



Fan assisted



Eco



Large grill



Fan grill (large)



Fan assisted base

## Hob options



<b>Control lock</b>	Yes	<b>Limited Power Consumption Mode</b>	Yes
<b>End cooking timer</b>	4	<b>Limited Power Consumption Mode in W</b>	1000, 1600, 2200, 2800, 3500, 6000, 7200 W
<b>Minute minder</b>	1		

## Hob technical features



**Total no. of cook zones** 4

Front left - Induction - single - 1.60 kW - Booster 2.10 kW - Ø 21.0 cm

Rear left - Induction - single - 1.20 kW - Booster 1.60 kW - Ø 15.0 cm

Rear right - Induction - single - 1.60 kW - Booster 2.10 kW - Ø 21.0 cm

Front right - Induction - single - 1.20 kW - Booster 1.60 kW - Ø 15.0 cm

<b>No. of cooking zones with Booster</b>	4	<b>Minimum pan diameter indication</b>	Yes
<b>Automatic switch off when overheat</b>	Yes	<b>Selected zone indicator</b>	Yes
<b>Automatic pan detection</b>	Yes	<b>Residual heat indicator</b>	Yes

## Main Oven Technical Features



<b>No. of lights</b>	1	<b>Removable inner door</b>	Yes
<b>Fan number</b>	1	<b>Total no. of door glasses</b>	3
<b>Net volume of the cavity</b>	70 l	<b>No. of thermo-reflective door glasses</b>	2
<b>Gross volume, 1st cavity</b>	79 l	<b>Safety Thermostat</b>	Yes
<b>Cavity material</b>	Ever Clean enamel	<b>Cooling system</b>	Tangential
<b>No. of shelves</b>	5	<b>Usable cavity space dimensions (HxWxD)</b>	360X460X425 mm
<b>Type of shelves</b>	Metal racks	<b>Temperature control</b>	Electro-mechanical
<b>Light type</b>	Halogen	<b>Lower heating element power</b>	1200 W
<b>Light Power</b>	40 W	<b>Upper heating element - Power</b>	1000 W
<b>Cooking time setting</b>	Stop	<b>Grill element</b>	1700 W
<b>Door opening</b>	Flap down	<b>Large grill - Power</b>	2700 W
<b>Removable door</b>	Yes	<b>Grill type</b>	Electric
<b>Full glass inner door</b>	Yes		

## Options Main Oven

<b>Timer</b>	Yes	<b>Minimum Temperature</b>	50 °C
<b>End of cooking acoustic alarm</b>	Yes	<b>Maximum temperature</b>	260 °C

## Accessories included for Main Oven & Hob

Rack with back and side stop	1	40mm deep tray	1
------------------------------	---	----------------	---

## Electrical Connection

Plug	Not present	Electric cable	Installed, Single phase
Electrical connection rating	10000 W	Additional connection modalities	Double and Three Phase
Current	44 A	Frequency	50/60 Hz
Voltage	220-240 V	Terminal block	5 poles
Voltage 2 (V)	380-415 V		

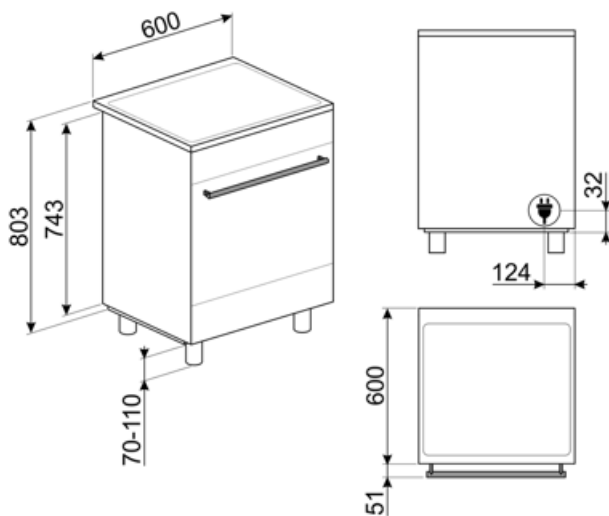

## Not included accessories



### BN620-1

Enamelled tray suitable for 45cm and 60cm ovens. Depth 20 mm. Perfect for a wide range of savoury and sweet baking.



### BNP608T

Teflon-coated tray, 8mm depth, to be placed on the grid



### GTT

Totally extractable telescopic guides (1 level), suitable for traditional ovens. Made in stainless steel, they guarantee stability and facilitate the smooth extraction of the trays.



### KITP60X9

Splashback, stainless steel, suitable for 60X60cm Concerto cookers with pyro and MF oven



### PALPZ

Pizza shovel with folding handle. Dimensions L31.5 x H32.5 cm. Easy and convenient to use and store. Perfect for serving pizza, bread and savory pastries in a safe and professional way.



### SCRIP

Non-scratch hob scraper - suitable for induction and ceramic hobs



### BN640

Enamelled tray suitable for 45cm and 60cm ovens. Depth 540 mm. Perfect for cooking and roasting meat and fish in sauces. Also ideal for experimenting with lighter and crunchy side dishes



### GTP

Partially extractable telescopic guides (1 level), suitable for traditional ovens. Made in stainless steel, they guarantee stability and facilitate the smooth extraction of the trays.



### KITH95

Height extension feet (950mm), stainless steel, suitable for Concerto cookers (911-966mm)



### KITPDQ

Height reduction feet (850mm), stainless steel, for Concerto cookers (850-881mm)



### PRTX

Refractory pizza stone with handles. D=35cm Not suitable for microwave ovens. Suitable for gas ovens, to be put on the griddle.



### SFLK1

Child lock

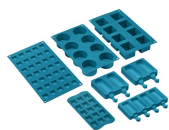

### SMOLD



















Set of 7 silicone moulds for ice creams, ice lollies, pralines, ice cubes or to portion food. Usable from -60°C to +230°C











### STONE

Rectangular refractory stone Ideal for cooking pizzas with the same results as a typical wood-fired oven. Can also be used for baking bread, focaccias and other recipes such as pies, flans or biscuits Dimensions:L42 x H1,8 x P37,5 cm.

## Symbols glossary

 <p>Power booster: option allows the zone to work at full power when very intense cooking is necessary.</p>	 <p>Child lock: some models are fitted with a device to lock the programme/cycle so it cannot be accidentally changed.</p>
	 <p>Installation in column: Installation in column</p>
 <p>Touch control</p>	 <p>Air cooling system: to ensure a safe surface temperatures.</p>
 <p>4.3 inch display with LED technology, usability with knobs + 3 touch keys</p>	 <p>Triple glazed doors: Number of glazed doors.</p>
 <p>ECO-logic: option allows you to restrict the power limit of the appliance real energy saving.</p>	 <p>Ever Clean Enamel: Ever Clean enamel is applied electrostatically, corner to corner and edge to edge to prevent cracking or cracks over time. It is a particular pyrolytic enamel, resistant to acids which, in addition to being pleasantly bright, promotes greater cleaning of the oven walls, thanks to its lower porosity. It is baked at over 850 ° C and slowly polymerized at a scientifically determined rate to ensure uniform depth and strength Ever Clean enamel creates an impeccable finish both on the inside of the oven and on the trays, making the surfaces of the oven incredibly easy to maintain over time as it reduces the adhesion of fat during cooking</p>
 <p>Fan assisted base: the mix of fan and lower heating element alone allows to finish cooking foods already cooked on the surface but not internally more quickly. This system is recommended to finish cooking foods that are already well cooked on the surface, but not internally, which therefore require a moderate higher heat. Ideal for any type of food.</p>	 <p>Fan assisted: Intense and homogeneous traditional cooking, also suitable for complex recipes. The fan is active and the heat comes from below and from above at the same time. Ventilated cooking ensures a faster and more homogeneous result, leaving fragrant foods outside and moister inside. Ideal for baked pasta, biscuits, roasts and cobblers.</p>
 <p>Static: Traditional cooking suitable for the preparation of one dish at a time. The fan is not active and the heat comes from below and from above at the same time. Static cooking is slower and more delicate, ideal in order to get well cooked and dry dishes even inside. Ideal for cooking all types of roasts, fatty meats, bread, filled cakes.</p>	 <p>ECO: low energy consumption cooking: this function is particularly suitable for cooking on a single shelf with low energy consumption. It is recommended for all types of food except those that can generate a lot of moisture (for example vegetables). To achieve maximum energy savings and reduce time, it is recommended to put the food in the oven without preheating the cooking compartment</p>
 <p>Grill: Very intense heat coming only from above from a double heating element. The fan is not active. Provides excellent grilling and gratinating results. Used at the end of cooking, it gives a uniform browning to dishes.</p>	 <p>Fan grill: very intense heat coming only from above from a double heating element The fan is active. It allows the optimal grilling of thickest meats. Ideal for large cuts of meat.</p>
 <p>Overheat protection: The safety system that automatically turns off the hob in case of overheating of the control unit.</p>	 <p>Induction: The work of these hobs is based on the principle of electromagnetic induction. The heat is generated directly in the bottom of the pan during its contact with the hob.</p>

- 
-  All glass inner door: All glass inner door, a single flat surface which is simple to keep clean.
  -  Side lights: Two opposing side lights increase visibility inside the oven.
  -  Indication of residual heat: After the glass ceramic hob is switched off the residual heat indicator shows which of the heating zones still remains hot. When the temperature drops below 60 ° C, the indicator goes out.
  -  Timer: All ceramic hobs have a timer which automatically ends cooking after a preset time.
  -  The capacity indicates the amount of usable space in the oven cavity in litres.
  -  The inner door glass: can be removed with a few quick movements for cleaning.
  -  Automatic opening: some models have Automatic opening door when the cycle is finished which is a perfect solution for handle-less kitchen units as no handle is needed. For safety reasons, the door locks automatically when the machine is in use to avoid it being opened inadvertently.
  -  The oven cavity has 5 different cooking levels.
  -  Vapor Clean: a simple cleaning function using steam to loosen deposits in the oven cavity.

## Benefit (TT)

---

### **Induction hob**

Induction offers fast cooking and precise temperature control

Through the use of suitable cookware, induction is easy to use and maintain, safe and responsive.

### **Vapor Clean**

By inserting water into a recess at the bottom of the cavity, steam is generated, which softens the residue and facilitates its removal

By inserting water into a recess at the bottom of the cavity, steam is generated, which softens the residue and facilitates its removal.

### **Touch control**

Easy and intuitive timer setting with a single touch

### **Single turbine**

The oven has a fan equipped with a circular heating element allowing cooking with rotating heat

### **Isothermic Cavity**

The best cooking performance at the highest energy efficiency

### **Tangential cooling**

New cooling system with tangential fan and airflow from the door to the splashback

### **Multilevel halogen light**

Internal halogen lighting on different levels guarantees excellent visibility

### **Adjustable height**

Cooker top flushed with the working area thanks to adjustable feet

### **Removable inner glass**

Internal door glasses are easily removable for complete cleaning

### **Multilevel cooking**

Several cooking levels allow maximum flexibility of use

### **Cold door**

During any function, the external door glass is cold, avoiding any risk of burns

### **AirFry (AIRFRY optional accessory)**

Lighter and tastier food thanks to airfry basket (optional accessory)



---

**BBQ (optional accessory)**

Barbeque cooking directly in the oven with the double-sided grill (BBQ optional accessory)

**Pizza stone (optional accessory)**

Baking with refractory stone for soft and crispy pizza and yeast products (STONE optional accessory)